

Chapter 7 Systems and Matrices

Section 7.1 Solving Systems of Two Equations

Exploration 1

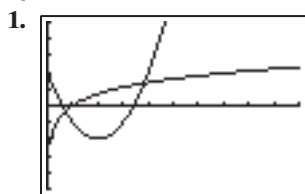

[0, 10] by [-5, 5]

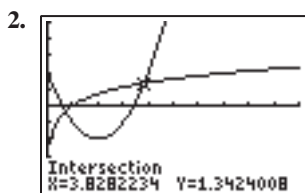

[0, 10] by [-5, 5]

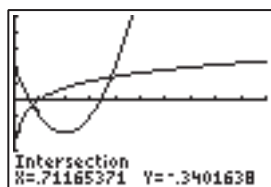

[0, 10] by [-5, 5]

3. The function $\ln x$ is only defined for $x > 0$, so all solutions must be positive. As x approaches infinity, $x^2 - 4x + 2$ is going to infinity much more quickly than $\ln x$ is going to infinity, hence will always be larger than $\ln x$ for x -values greater than 4.

Quick Review 7.1

1. $3y = 5 - 2x$

$$y = \frac{5}{3} - \frac{2}{3}x$$

2. $x(y + 1) = 4$

$$y + 1 = \frac{4}{x}, x \neq 0$$

$$y = \frac{4}{x} - 1$$

3. $(3x + 2)(x - 1) = 0$

$$3x + 2 = 0 \quad \text{or} \quad x - 1 = 0$$

$$3x = -2 \quad \quad \quad x = 1$$

$$x = -\frac{2}{3}$$

4. $x = \frac{-5 \pm \sqrt{5^2 - 4(2)(-10)}}{4}$

$$= \frac{-5 \pm \sqrt{105}}{4}$$

$$x = \frac{-5 + \sqrt{105}}{4}, \frac{-5 - \sqrt{105}}{4}$$

5. $x^3 - 4x = 0$

$$x(x^2 - 4) = 0$$

$$x(x - 2)(x + 2) = 0$$

$$x = 0, x = 2, x = -2$$

6. $x^3 + x^2 - 6x = 0$

$$x(x^2 + x - 6) = 0$$

$$x(x + 3)(x - 2) = 0$$

$$x = 0, x = -3, x = 2$$

7. $m = -\frac{4}{5}, y - 2 = -\frac{4}{5}(x + 1)$

$$y = -\frac{4}{5}x - \frac{4}{5} + 2$$

$$y = \frac{-4x + 6}{5}$$

8. $m = \frac{5}{4}, y - 2 = \frac{5}{4}(x + 1)$

$$y = \frac{5}{4}x + \frac{5}{4} + 2$$

$$y = \frac{5x + 13}{4}$$

9. $-2(2x + 3y) = -2(5)$

$$-4x - 6y = -10$$

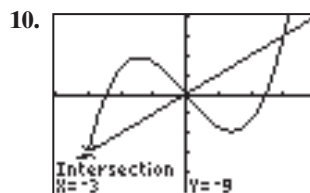

[-4, 4] by [-15, 12]

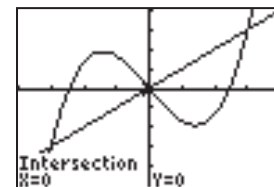

[-4, 4] by [-15, 12]

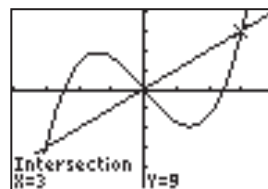

[-4, 4] by [-15, 12]

Section 7.1 Exercises

1. (a) No: $5(0) - 2(4) \neq 8$.

(b) Yes: $5(2) - 2(1) = 8$ and $2(2) - 3(1) = 1$.

(c) No: $2(-2) - 3(-9) \neq 1$.

2. (a) Yes: $-3 = 2^2 - 6(2) + 5$ and $-3 = 2(2) - 7$.

(b) No: $-5 \neq 1^2 - 6(1) + 5$.

(c) Yes: $5 = 6^2 - 6(6) + 5$ and $5 = 2(6) - 7$.

In #3–12, there may be more than one good way to choose the variable for which the substitution will be made. One approach is given. In most cases, the solution is only shown up to the point where the value of the first variable is found.

3. $(x, y) = (9, -2)$: Since $y = -2$, we have $x - 4 = 5$, so $x = 9$.

4. $(x, y) = (3, -17)$: Since $x = 3$, we have $3 - y = 20$, so $y = -17$.

5. $(x, y) = \left(\frac{50}{7}, -\frac{10}{7}\right)$: $y = 20 - 3x$,
 so $x - 2(20 - 3x) = 10$, or $7x = 50$, so $x = \frac{50}{7}$.
6. $(x, y) = \left(-\frac{23}{5}, \frac{23}{5}\right)$: $y = -x$,
 so $2x + 3x = -23$, or $x = -\frac{23}{5}$.
7. $(x, y) = \left(-\frac{1}{2}, 2\right)$: $x = (3y - 7)/2$,
 so $2(3y - 7) + 5y = 8$, or $11y = 22$, so $y = 2$.
8. $(x, y) = (-3, 2)$: $x = (5y - 16)/2$, so
 $1.5(5y - 16) + 2y = -5$, or $9.5y = 19$, so $y = 2$.
9. No solution: $x = 3y + 6$, so $-2(3y + 6) + 6y = 4$,
 or $-12 = 4$ — not true.
10. There are infinitely many solutions, any pair $(x, 3x + 2)$:
 From the first equation, $y = 3x + 2$, so $-9x + 3(3x + 2) = 6$, or $6 = 6$ — always true.
11. $(x, y) = (\pm 3, 9)$: The second equation gives $y = 9$,
 so, $x^2 = 9$, or $x = \pm 3$.
12. $(x, y) = (0, -3)$ or $(x, y) = (4, 1)$: Since $x = y + 3$,
 we have $y + 3 - y^2 = 3y$, or $y^2 + 2y - 3 = 0$.
 Therefore $y = -3$ or $y = 1$.
13. $(x, y) = \left(-\frac{3}{2}, \frac{27}{2}\right)$ or $(x, y) = \left(\frac{1}{3}, \frac{2}{3}\right)$:
 $6x^2 + 7x - 3 = 0$, so $x = -\frac{3}{2}$ or $x = \frac{1}{3}$. Substitute these
 values into $y = 6x^2$.
14. $(x, y) = (-4, 28)$ or $(x, y) = \left(\frac{5}{2}, 15\right)$:
 $2x^2 + 3x - 20 = 0$, so $x = -4$ or $x = \frac{5}{2}$.
 Substitute these values into $y = 2x^2 + x$.
15. $(x, y) = (0, 0)$ or $(x, y) = (3, 18)$: $3x^2 = x^3$, so $x = 0$ or
 $x = 3$. Substitute these values into $y = 2x^2$.
16. $(x, y) = (0, 0)$ or $(x, y) = (-2, -4)$: $x^3 + 2x^2 = 0$, so
 $x = 0$ or $x = -2$. Substitute these values into $y = -x^2$.
17. $(x, y) = \left(\frac{-1 + 3\sqrt{89}}{10}, \frac{3 + \sqrt{89}}{10}\right)$ and
 $\left(\frac{-1 - 3\sqrt{89}}{10}, \frac{3 - \sqrt{89}}{10}\right)$: $x - 3y = -1$, so $x = 3y + 1$.
 Substitute $x = 3y + 1$ into $x^2 + y^2 = 9$:
 $(3y + 1)^2 + y^2 = 9 \Rightarrow 10y^2 - 6y - 8 = 0$. Using the
 quadratic formula, we find that $y = \frac{3 \pm \sqrt{89}}{10}$.
18. $(x, y) = \left(\frac{52 + 7\sqrt{871}}{65}, \frac{91 - 4\sqrt{871}}{65}\right)$
 $\approx (3.98, -0.42)$ or
 $(x, y) = \left(\frac{52 - 7\sqrt{871}}{65}, \frac{91 + 4\sqrt{871}}{65}\right)$
 $\approx (-2.38, 3.22)$: $\frac{1}{16}(13 - 7y)^2 + y^2 = 16$, so
 $65y^2 - 182y - 87 = 0$. Then $y = \frac{1}{65}(91 \pm 4\sqrt{871})$.

Substitute into $x = \frac{1}{4}(13 - 7y)$ to get
 $x = \frac{1}{65}(52 \mp 7\sqrt{871})$.

In the following, \mathbf{E}_1 and \mathbf{E}_2 refer to the first and second equations, respectively.

19. $(x, y) = (8, -2)$: $\mathbf{E}_1 + \mathbf{E}_2$ leaves $2x = 16$,
 so $x = 8$.
20. $(x, y) = (3, 4)$: $2\mathbf{E}_1 + \mathbf{E}_2$ leaves $5x = 15$,
 so $x = 3$.
21. $(x, y) = (4, 2)$: $2\mathbf{E}_1 + \mathbf{E}_2$ leaves $11x = 44$,
 so $x = 4$.
22. $(x, y) = (-2, 3)$: $4\mathbf{E}_1 + 5\mathbf{E}_2$ leaves $31x = -62$,
 so $x = -2$.
23. No solution: $3\mathbf{E}_1 + 2\mathbf{E}_2$ leaves $0 = -72$, which is false.
24. There are infinitely many solutions, any pair $\left(x, \frac{1}{2}x - 2\right)$:
 $\mathbf{E}_1 + 2\mathbf{E}_2$ leaves $0 = 0$, which is always true. As long as
 (x, y) satisfies one equation, it will also satisfy the other.
25. There are infinitely many solutions, any pair $\left(x, \frac{2}{3}x - \frac{5}{3}\right)$:
 $3\mathbf{E}_1 + \mathbf{E}_2$ leaves $0 = 0$, which is always true. As long as
 (x, y) satisfies one equation, it will also satisfy the other.
26. No solution: $2\mathbf{E}_1 + \mathbf{E}_2$ leaves $0 = 11$, which is false.
27. $(x, y) = (0, 1)$ or $(x, y) = (3, -2)$
28. $(x, y) = (1.5, 1)$
29. No solution
30. $(x, y) = (0, -4)$ or $(x, y) = (\pm\sqrt{7}, 3) \approx (\pm 2.65, 3)$
31. One solution

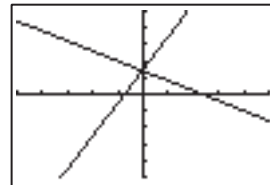

$[-5, 5]$ by $[-5, 5]$

32. No solution

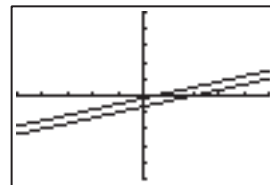

$[-5, 5]$ by $[-5, 5]$

33. Infinitely many solutions

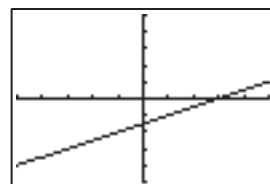

$[-5, 5]$ by $[-5, 5]$

34. One solution

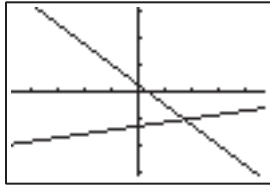

$[-4.7, 4.7]$ by $[-3.1, 3.1]$

35. $(x, y) \approx (0.69, -0.37)$

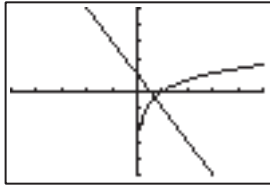

$[-5, 5]$ by $[-5, 5]$

36. $(x, y) \approx (1.13, 1.27)$

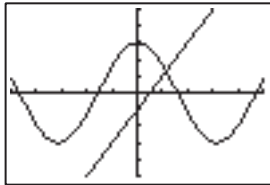

37. $(x, y) \approx (-2.32, -3.16)$ or $(0.47, -1.77)$ or $(1.85, -1.08)$

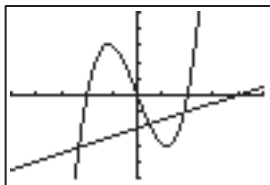

$[-5, 5]$ by $[-5, 5]$

38. $(x, y) \approx (-0.70, -2.40)$ or $(5.70, 10.40)$

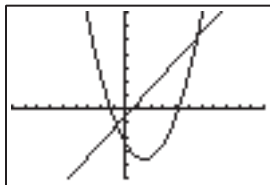

$[-9, 11]$ by $[-10, 14]$

39. $(x, y) = (-1.2, 1.6)$ or $(2, 0)$

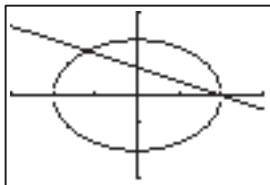

$[-3, 3]$ by $[-3, 3]$

40. $(x, y) \approx (-1.2, -1.6)$ or $(2, 0)$

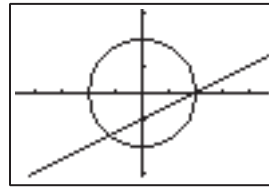

$[-4.7, 4.7]$ by $[-3.1, 3.1]$

41. $(x, y) \approx (2.05, 2.19)$ or $(-2.05, 2.19)$

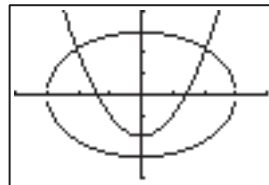

$[-4, 4]$ by $[-4, 4]$

42. $(x, y) \approx (2.05, -2.19)$ or $(-2.05, -2.19)$

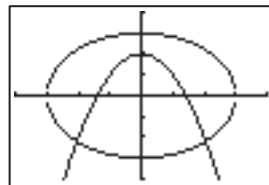

$[-4, 4]$ by $[-4, 4]$

43. $(x, p) = (3.75, 143.75)$: $200 - 15x = 50 + 25x$, so $40x = 150$.

44. $(x, p) = (130, 5.9)$: $15 - 0.07x = 2 + 0.03x$, so $0.10x = 13$.

45. In this problem, the graphs are representative of the expenditures (in billions of dollars) for benefits and administrative costs from federal hospital and medical insurance trust funds for several years, where x is the number of years past 1980.

(a) The following is a scatter plot of the data with the quadratic regression equation $y = -0.0938x^2 + 15.0510x - 28.2375$ superimposed on it.

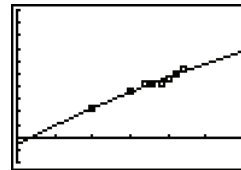

$[0, 30]$ by $[-100, 500]$

(b) The following is a scatter plot of the data with the logistic regression equation $y = \frac{353.6473}{1 + 8.6873e^{-0.1427x}}$ superimposed on it.

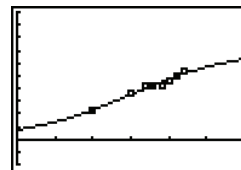

$[0, 30]$ by $[-100, 500]$

(c) Quadratic regression model

Graphical solution: Graph the line $y = 300$ with the quadratic regression curve $y = -0.0938x^2 + 15.0510x - 28.2375$ and find the intersection of the two curves. The two intersect at $x \approx 26.03$. The expenditures will be 300 billion dollars sometime in the year 2006.

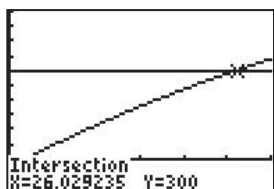

[0, 30] by [-100, 500]

Another graphical solution would be to find where the graph of the difference of the two curves is equal to 0. Note: The quadratic and the line intersect in two points, but the second point is an unrealistic answer. This would be sometime in the year 2114.

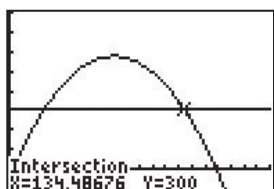

[0, 200] by [-100, 800]

Algebraic solution: Solve

$$300 = -0.0938x^2 + 15.0510x - 28.2375 \text{ for } x.$$

Use the quadratic formula to solve the equation $-0.0938x^2 + 15.0510x - 328.2375 = 0$.

$$a = -0.0938 \quad b = 15.0510 \quad c = -328.2375$$

$$x = \frac{-15.0510 \pm \sqrt{(15.0510)^2 - 4(-0.0938)(-328.2375)}}{2(-0.0938)}$$

$$x = \frac{-15.0510 \pm \sqrt{226.5326 - 123.1547}}{-0.1876}$$

$$= \frac{-15.0510 \pm 10.1675}{-0.1876}$$

$$x \approx 26.03 \text{ and } x \approx 134.43$$

We select $x = 26.03$, which indicates that the expenditures will be 300 billion dollars sometime in the year 2006.

Logistic regression model

Graphical solution: Graph the line $y = 300$ with the logistic regression curve $y = \frac{353.6473}{(1 + 8.6873e^{-0.1427x})}$ and find the intersection of the two curves. The two intersect at $x \approx 27.21$.

The expenditures will be 300 billion dollars sometime in the year 2007.

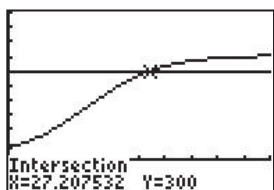

[0, 50] by [-100, 500]

Another graphical solution would be to find where the graph of the difference of the two curves is equal to 0.

Algebraic solution: Solve $300 = \frac{353.6473}{(1 + 8.6873e^{-0.1427x})}$ for x .

$$300(1 + 8.6873e^{-0.1427x}) = 353.6473$$

$$8.687e^{-0.1427x} = \frac{353.6473}{300} - 1$$

$$8.687e^{-0.1427x} = 1.1788 - 1 = 0.1788$$

$$e^{-0.1427x} = \frac{0.1788}{8.687} = 0.0202$$

$$-0.1427x = \ln 0.0202$$

$$x = \frac{\ln 0.0202}{-0.1427} \approx 27.34$$

The expenditures will be 300 billion dollars sometime in the year 2007.

(d) The long-range implication of using the quadratic regression equation is that the expenditures will eventually fall to zero.

(The graph of the function is a parabola with vertex at about (80, 576) and it opens downward. So, eventually the curve will cross the x -axis and the expenditures will be 0. This will happen when $x \approx 158$.)

(e) The long-range implication of using the logistic regression equation is that the expenditures will eventually level off at about 354 billion dollars. (We notice that as x gets larger, $e^{-0.1427x}$ approaches 0. Therefore, the denominator of the function approaches 1 and the function itself approaches 353.65, which is about 354.)

46. In this problem, the graphs are representative of the total personal income (in billions of dollars) for residents of the states of (a) Iowa and (b) Nevada for several years, where x is the number of years past 1990.

(a) The following is a scatter plot of the Iowa data with the linear regression equation $y = 2.8763x + 48.4957$ superimposed on it.

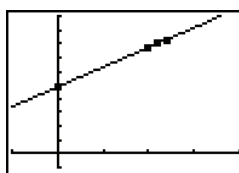

[-5, 20] by [-10, 100]

(b) The following is a scatter plot of the Nevada data with the linear regression equation $y = 3.5148x + 25.0027$ superimposed on it.

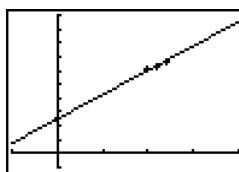

[-5, 20] by [-10, 100]

(c) *Graphical solution:* Graph the two linear equations $y = 2.8763x + 48.4957$ and $y = 3.5148x + 25.0027$ on the same axes and find the point of intersection. The two curves intersect at $x \approx 36.8$.

The personal incomes of the two states will be the same sometime in the year 2026.

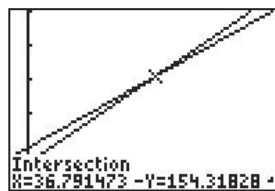

[-5, 70] by [-10, 250]

Another graphical solution would be to find where the graph of the difference of the two curves is equal to 0.

Algebraic solution:

Solve $2.8763x + 48.4957 = 3.5148x + 25.0027$ for x .

$$2.8763x + 48.4957 = 3.5148x + 25.0027$$

$$0.6385x = 23.4930$$

$$x = \frac{23.4930}{0.6385} \approx 36.8$$

The personal incomes of the two states will be the same sometime in the year 2026.

47. In this problem, the graphs are representative of the population (in thousands) of the states of Arizona and Massachusetts for several years, where x is the number of years past 1980.

- (a) The following is a scatter plot of the Arizona data with the linear regression equation $y = 127.6351x + 2587.0010$ superimposed on it.

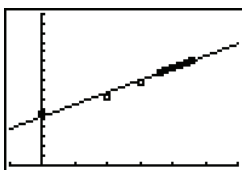

[-5, 30] by [0, 8000]

- (b) The following is a scatter plot of the Massachusetts data with the linear regression equation $y = 31.3732x + 5715.9742$ superimposed on it.

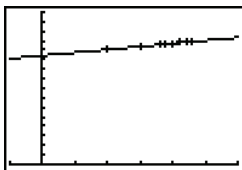

[-5, 30] by [0, 8000]

- (c) *Graphical solution:* Graph the two linear equations $y = 127.6351x + 2587.0010$ and $y = 31.3732x + 5715.9742$ on the same axes and find the point of intersection. The two curves intersect at $x \approx 32.5$.

The population of the two states will be the same sometime in the year 2012.

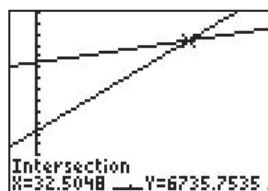

[-5, 50] by [0, 8000]

Another graphical solution would be to find where the graph of the difference of the two curves is equal to 0.

Algebraic solution:

Solve $127.6351x + 2587.0010 = 31.3732x + 5715.9742$ for x .

$$127.6351x + 2587.0010 = 31.3732x + 5715.9742$$

$$96.2619x = 3128.9732$$

$$x = \frac{3128.9732}{96.2619} \approx 32.5$$

The population of the two states will be the same sometime in the year 2012.

48. (a) None: the line never crosses the circle.
One: the line touches the circle at only one point—a tangent line.
Two: the line intersects the circle at two points.
- (b) None: the parabola never crosses the circle.
One, two, three, or four: the parabola touches the circle in one, two, three or four points.
49. $200 = 2(x + y)$ and $500 = xy$. Then $y = 100 - x$, so $500 = x(100 - x)$, and therefore $x = 50 \pm 20\sqrt{5}$, and $y = 50 \mp 20\sqrt{5}$. Both answers correspond to a rectangle with approximate dimensions $5.28 \text{ m} \times 94.72 \text{ m}$.
50. $220 = 2(x + y)$ and $3000 = xy$. Then $y = 110 - x$, so $3000 = x(110 - x)$, and therefore $x = 50$ or 60 . That means $y = 60$ or 50 ; the rectangle has dimensions $50 \text{ yd} \times 60 \text{ yd}$.
51. If r is Hank's rowing speed (in miles per hour) and c is the speed of the current, $\frac{24}{60}(r - c) = 1$ and $\frac{13}{60}(r + c) = 1$. Therefore $r = c + \frac{5}{2}$ (from the first equation); substituting gives $\frac{13}{60}\left(2c + \frac{5}{2}\right) = 1$, so $2c = \frac{60}{13} - \frac{5}{2} = \frac{55}{26}$, and $c = \frac{55}{52} \approx 1.06$ mph. Finally, $r = c + \frac{5}{2} = \frac{185}{52} \approx 3.56$ mph.
52. If x is airplane's speed (in miles per hour) and y is the wind speed, $4.4(x - y) = 2500$ and $3.75(x + y) = 2500$. Therefore $x = y + 568.18$; substituting gives $3.75(2y + 568.18) = 2500$, so $2y = 98.48$, and $y = 49.24$ mph. Finally, $x = y + 568.18 = 617.42$ mph.
53. $m + \ell = 1.74$ and $\ell = m + 0.16$, so $2m + 0.16 = 1.74$. Then $m = \$0.79$ (79 cents) and $\ell = \$0.95$ (95 cents).

54. $p + c = 5$ and $1.70p + 4.55c = 2.80 \cdot 5$. Then $1.70(5 - c) + 4.55c = 14$, so $2.85c = 5.5$. That means $c = \frac{110}{57} \approx 1.93$ lb of cashews and $p = \frac{175}{57} \approx 3.07$ lb of peanuts.

55. $4 = -a + b$ and $6 = 2a + b$, so $b = a + 4$ and $6 = 3a + 4$. Then $a = \frac{2}{3}$ and $b = \frac{14}{3}$.

56. $2a - b = 8$ and $-4a - 6b = 8$, so $b = 2a - 8$ and $8 = -4a - 6(2a - 8) = -16a + 48$. Then $a = \frac{40}{16} = \frac{5}{2}$ and $b = -3$.

57. (a) Let $C(x)$ = the amount charged by each rental company, and let x = the number of miles driven by Pedro.

Company A: $C(x) = 40 + 0.10x$

Company B: $C(x) = 25 + 0.15x$

Solving these two equations for x ,

$$40 + 0.10x = 25 + 0.15x$$

$$15 = 0.05x$$

$$300 = x$$

Pedro can drive 300 miles to be charged the same amount by the two companies.

(b) One possible answer: If Pedro is making only a short trip, Company B is better because the flat fee is less. However, if Pedro drives the rental van over 300 miles, Company A's plan is more economical for his needs.

58. (a) Let $S(x)$ = Stephanie's salary, and let x = total sales from household appliances sold weekly.

Plan A: $S(x) = 300 + 0.05x$

Plan B: $S(x) = 600 + 0.01x$

Solving these equations, we find:

$$300 + 0.05x = 600 + 0.01x$$

$$0.04x = 300$$

$$x = 7500$$

Stephanie's sales must be exactly \$7500 for the plans to provide the same salary.

(b) One possible answer: If Stephanie expects that her sales will generally be above \$7500 each week, then Plan A provides a better salary. If she believes that sales will not reach \$7500/week, however, Plan B will maximize her salary.

59. False. A system of two linear equations in two variables has either 0, 1, or infinitely many solutions.

60. False. The system would have no solutions, because any solution of the original system would have to be a solution of $7 = 0$, which has no solutions.

61. Using $(x, y) = (3, -2)$,

$$2(3) - 3(-2) = 12$$

$$3 + 2(-2) = -1$$

The answer is C.

62. A parabola and a circle can intersect in at most 4 places. The answer is E.

63. Two parabolas can intersect in 0, 1, 2, 3, or 4 places, or infinitely many places if the parabolas completely coincide. The answer is D.

64. When the solution process leads to an identity (an equation that is true for all (x, y)), the original system has infinitely many solutions. The answer is E.

65. (a) $\frac{x^2}{4} + \frac{y^2}{9} = 1$

$$9x^2 + 4y^2 = 36$$

$$4y^2 = 36 - 9x^2$$

$$y^2 = \frac{36 - 9x^2}{4}$$

$$y = \frac{3}{2}\sqrt{4 - x^2}, y = -\frac{3}{2}\sqrt{4 - x^2}$$

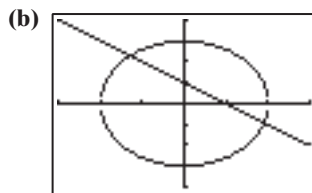

$[-3, 3]$ by $[-4, 4]$

$$(x, y) \approx (-1.29, 2.29) \text{ or } (1.91, -0.91)$$

(c) $\frac{(-1.29)^2}{4} + \frac{(2.29)^2}{9} \approx 0.9987 \approx 1$ and

$$(-1.29) + (2.29) = 1, \text{ so the first solution checks.}$$

$$\frac{(1.91)^2}{4} + \frac{(-0.91)^2}{9} \approx 1.004 \approx 1 \text{ and}$$

$$(1.91) + (-0.91) = 1, \text{ so the second solution checks.}$$

66. (a) $\frac{x^2}{4} - \frac{y^2}{9} = 1$

$$-9x^2 + 4y^2 = -36$$

$$4y^2 = 9x^2 - 36$$

$$y^2 = \frac{9x^2 - 36}{4}$$

$$y = \frac{3}{2}\sqrt{x^2 - 4}, y = -\frac{3}{2}\sqrt{x^2 - 4}$$

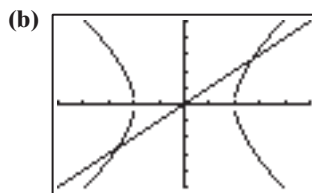

$[-5, 5]$ by $[-5, 5]$

$$(x, y) \approx (2.68, 2.68) \text{ or } (-2.68, -2.68)$$

(c) $\frac{(2.68)^2}{4} - \frac{(2.68)^2}{9} = \frac{(-2.68)^2}{4} - \frac{(-2.68)^2}{9}$

$$\approx 0.9976 \approx 1, \text{ so both solutions check.}$$

67. Subtract the second equation from the first, leaving

$$-3y = -10, \text{ or } y = \frac{10}{3}. \text{ Then } x^2 = 4 - \frac{10}{3} = \frac{2}{3}, \text{ so}$$

$$x = \pm\sqrt{\frac{2}{3}}.$$

68. Add the two equations to get $2x^2 = 2$, so $x^2 = 1$, and therefore $x = \pm 1$. Then $y = 0$.

69. The vertex of the parabola $R = (100 - 4x)x = 4x(25 - x)$ has first coordinate $x = 12.5$ units.

70. The local maximum of $R = x(80 - x^2) = 80x - x^3$ has first coordinate $x \approx 5.16$ units.

Section 7.2 Matrix Algebra

Exploration 1

- $a_{11} = 3(1) - (1) = 2$ Set $i = j = 1$.
 $a_{12} = 3(1) - (2) = 1$ Set $i = 1, j = 2$.
 $a_{21} = 3(2) - (1) = 5$ Set $i = 2, j = 1$.
 $a_{22} = 3(2) - (2) = 4$ Set $i = j = 2$.

So, $A = \begin{bmatrix} 2 & 1 \\ 5 & 4 \end{bmatrix}$. Similar computations show that

$$B = \begin{bmatrix} -1 & 2 \\ 2 & 5 \end{bmatrix}.$$

- The additive inverse of A is $-A$ and

$$-A = \begin{bmatrix} -2 & -1 \\ -5 & -4 \end{bmatrix}.$$

$$A + (-A) = \begin{bmatrix} 2 & 1 \\ 5 & 4 \end{bmatrix} + \begin{bmatrix} -2 & -1 \\ -5 & -4 \end{bmatrix} = \begin{bmatrix} 0 & 0 \\ 0 & 0 \end{bmatrix} = [0]$$

The order of $[0]$ is 2×2 .

- $3A - 2B = 3 \begin{bmatrix} 2 & 1 \\ 5 & 4 \end{bmatrix} - 2 \begin{bmatrix} -1 & 2 \\ 2 & 5 \end{bmatrix}$
 $= \begin{bmatrix} 6 & 3 \\ 15 & 12 \end{bmatrix} - \begin{bmatrix} -2 & 4 \\ 4 & 10 \end{bmatrix} = \begin{bmatrix} 8 & -1 \\ 11 & 2 \end{bmatrix}$

Exploration 2

- $\det(A) = -a_{12}a_{21}a_{33} + a_{13}a_{21}a_{32} + a_{11}a_{22}a_{33}$
 $- a_{13}a_{22}a_{31} - a_{11}a_{23}a_{32} + a_{12}a_{23}a_{31}$

Each element contains an element from each row and each column due to a definition of a determinant.

Regardless of the row or column “picked” to apply the definition, all other elements of the matrix are eventually factored into the multiplication.

- $$\begin{vmatrix} a_{11} & a_{12} & a_{13} \\ a_{21} & a_{22} & a_{23} \\ a_{31} & a_{32} & a_{33} \end{vmatrix} = a_{11}(-1)^2 \begin{vmatrix} a_{22} & a_{23} \\ a_{32} & a_{33} \end{vmatrix}$$

 $+ a_{12}(-1)^3 \begin{vmatrix} a_{21} & a_{23} \\ a_{31} & a_{33} \end{vmatrix} + a_{13}(-1)^4 \begin{vmatrix} a_{21} & a_{22} \\ a_{31} & a_{32} \end{vmatrix}$
 $= a_{11}(a_{22}a_{33} - a_{23}a_{32}) - a_{12}(a_{21}a_{33} - a_{23}a_{31})$
 $+ a_{13}(a_{21}a_{32} - a_{22}a_{31})$
 $= a_{11}a_{22}a_{33} - a_{11}a_{23}a_{32} - a_{12}a_{21}a_{33} + a_{12}a_{23}a_{31}$
 $+ a_{13}a_{21}a_{32} - a_{13}a_{22}a_{31}$

The two expressions are exactly equal.

- Recall that A_{ij} is $(-1)^{i+j}M_{ij}$ where M_{ij} is the determinant of the matrix obtained by deleting the row and column containing a_{ij} . Let $A = k \times k$ square matrix with zeros in the i th row. Then: $\det(A) =$

$$\begin{matrix} & & & & a_{1k} \\ & & & & a_{2k} \\ & & & & \vdots \\ & & & & \vdots \\ \textit{ith row} \rightarrow & 0 & 0 & \dots & 0 \\ & \vdots & \vdots & & \vdots \\ & a_{k1} & a_{k2} & \dots & a_{kk} \end{matrix}$$

$$= 0 \cdot A_{i1} + 0 \cdot A_{i2} + \dots + 0 \cdot A_{ik} = 0 + 0 + \dots + 0 = 0$$

Quick Review 7.2

- $(3, 2)$
 - $(x, -y)$

- $(-3, -2)$
 - $(-x, y)$

- $(-2, 3)$
 - (y, x)

- $(2, -3)$
 - $(-y, -x)$

- $(2, -3)$
 - $(-y, -x)$

- $(2, -3)$
 - $(-y, -x)$

- $(2, -3)$
 - $(-y, -x)$

- $(3 \cos \theta, 3 \sin \theta)$

- $(r \cos \theta, r \sin \theta)$

- $\sin(\alpha + \beta) = \sin \alpha \cos \beta + \cos \alpha \sin \beta$

- $\sin(\alpha - \beta) = \sin \alpha \cos \beta - \cos \alpha \sin \beta$

- $\cos(\alpha + \beta) = \cos \alpha \cos \beta - \sin \alpha \sin \beta$

- $\cos(\alpha - \beta) = \cos \alpha \cos \beta + \sin \alpha \sin \beta$

Section 7.2 Exercises

- 2×3 ; not square

- 2×2 ; square

- 3×2 ; not square

- 1×3 ; not square

- 3×1 ; not square

- 1×1 ; square

- $a_{13} = 3$

- $a_{24} = -1$

- $a_{32} = 4$

- $a_{33} = -1$

- $\begin{bmatrix} 3 & 0 \\ -3 & 1 \end{bmatrix}$

- $\begin{bmatrix} 1 & 6 \\ 1 & 9 \end{bmatrix}$

- $\begin{bmatrix} 6 & 9 \\ -3 & 15 \end{bmatrix}$

- $2A - 3B = 2 \begin{bmatrix} 2 & 3 \\ -1 & 5 \end{bmatrix} - 3 \begin{bmatrix} 1 & -3 \\ -2 & -4 \end{bmatrix} =$

$$\begin{bmatrix} 4 & 6 \\ -2 & 10 \end{bmatrix} - \begin{bmatrix} 3 & -9 \\ -6 & -12 \end{bmatrix} = \begin{bmatrix} 1 & 15 \\ 4 & 22 \end{bmatrix}$$

- $\begin{bmatrix} 1 & 1 & 2 \\ 3 & 1 & 1 \\ 6 & -3 & 0 \end{bmatrix}$

- $\begin{bmatrix} -3 & -1 & 2 \\ 5 & 1 & -3 \\ -2 & 3 & 2 \end{bmatrix}$

- $\begin{bmatrix} -3 & 0 & 6 \\ 12 & 3 & -3 \\ 6 & 0 & 3 \end{bmatrix}$

- $2A - 3B = 2 \begin{bmatrix} -1 & 0 & 2 \\ 4 & 1 & -1 \\ 2 & 0 & 1 \end{bmatrix} - 3 \begin{bmatrix} 2 & 1 & 0 \\ -1 & 0 & 2 \\ 4 & -3 & -1 \end{bmatrix}$

$$= \begin{bmatrix} -2 & 0 & 4 \\ 8 & 2 & -2 \\ 4 & 0 & 2 \end{bmatrix} - \begin{bmatrix} 6 & 3 & 0 \\ -3 & 0 & 6 \\ 12 & -9 & -3 \end{bmatrix}$$

$$= \begin{bmatrix} -8 & -3 & 4 \\ 11 & 2 & -8 \\ -8 & 9 & 5 \end{bmatrix}$$

$$13. \text{ (a) } \begin{bmatrix} 1 & 1 \\ -2 & 0 \\ -1 & 0 \end{bmatrix}$$

$$\text{ (b) } \begin{bmatrix} -7 & 1 \\ 2 & -2 \\ 5 & 2 \end{bmatrix}$$

$$\text{ (c) } \begin{bmatrix} -9 & 3 \\ 0 & -3 \\ 6 & 3 \end{bmatrix}$$

$$\begin{aligned} \text{ (d) } 2A - 3B &= 2 \begin{bmatrix} -3 & 1 \\ 0 & -1 \\ 2 & 1 \end{bmatrix} - 3 \begin{bmatrix} 4 & 0 \\ -2 & 1 \\ -3 & -1 \end{bmatrix} \\ &= \begin{bmatrix} -6 & 2 \\ 0 & -2 \\ 4 & 2 \end{bmatrix} - \begin{bmatrix} 12 & 0 \\ -6 & 3 \\ -9 & -3 \end{bmatrix} = \begin{bmatrix} -18 & 2 \\ 6 & -5 \\ 13 & 5 \end{bmatrix} \end{aligned}$$

$$14. \text{ (a) } \begin{bmatrix} 3 & 1 & 4 & 1 \\ 3 & 0 & 1 & 0 \end{bmatrix}$$

$$\text{ (b) } \begin{bmatrix} 7 & -5 & 2 & 1 \\ -5 & 0 & 3 & 4 \end{bmatrix}$$

$$\text{ (c) } \begin{bmatrix} 15 & -6 & 9 & 3 \\ -3 & 0 & 6 & 6 \end{bmatrix}$$

$$\begin{aligned} \text{ (d) } 2A - 3B &= 2 \begin{bmatrix} 5 & -2 & 3 & 1 \\ -1 & 0 & 2 & 2 \end{bmatrix} - \\ &\quad 3 \begin{bmatrix} -2 & 3 & 1 & 0 \\ 4 & 0 & -1 & -2 \end{bmatrix} \\ &= \begin{bmatrix} 10 & -4 & 6 & 2 \\ -2 & 0 & 4 & 4 \end{bmatrix} - \\ &\quad \begin{bmatrix} -6 & 9 & 3 & 0 \\ 12 & 0 & -3 & -6 \end{bmatrix} \\ &= \begin{bmatrix} 16 & -13 & 3 & 2 \\ -14 & 0 & 7 & 10 \end{bmatrix} \end{aligned}$$

$$17. \text{ (a) } AB = \begin{bmatrix} (2)(1) + (3)(-2) & (2)(-3) + (3)(-4) \\ (-1)(1) + (5)(-2) & (-1)(-3) + (5)(-4) \end{bmatrix} = \begin{bmatrix} -4 & -18 \\ -11 & -17 \end{bmatrix}$$

$$\text{ (b) } BA = \begin{bmatrix} (1)(2) + (-3)(-1) & (1)(3) + (-3)(5) \\ (-2)(2) + (-4)(-1) & (-2)(3) + (-4)(5) \end{bmatrix} = \begin{bmatrix} 5 & -12 \\ 0 & -26 \end{bmatrix}$$

$$18. \text{ (a) } AB = \begin{bmatrix} (1)(5) + (-4)(-2) & (1)(1) + (-4)(-3) \\ (2)(5) + (6)(-2) & (2)(1) + (6)(-3) \end{bmatrix} = \begin{bmatrix} 13 & 13 \\ -2 & -16 \end{bmatrix}$$

$$\text{ (b) } BA = \begin{bmatrix} (5)(1) + (1)(2) & (5)(-4) + (1)(6) \\ (-2)(1) + (-3)(2) & (-2)(-4) + (-3)(6) \end{bmatrix} = \begin{bmatrix} 7 & -14 \\ -8 & -10 \end{bmatrix}$$

$$19. \text{ (a) } AB = \begin{bmatrix} (2)(1) + (0)(-3) + (1)(0) & (2)(2) + (0)(1) + (1)(-2) \\ (1)(1) + (4)(-3) + (-3)(0) & (1)(2) + (4)(1) + (-3)(-2) \end{bmatrix} = \begin{bmatrix} 2 & 2 \\ -11 & 12 \end{bmatrix}$$

$$\text{ (b) } BA = \begin{bmatrix} (1)(2) + (2)(1) & (1)(0) + (2)(4) & (1)(1) + (2)(-3) \\ (-3)(2) + (1)(1) & (-3)(0) + (1)(4) & (-3)(1) + (1)(-3) \\ (0)(2) + (-2)(1) & (0)(0) + (-2)(4) & (0)(1) + (-2)(-3) \end{bmatrix} = \begin{bmatrix} 4 & 8 & -5 \\ -5 & 4 & -6 \\ -2 & -8 & 6 \end{bmatrix}$$

$$20. \text{ (a) } AB = \begin{bmatrix} (1)(5) + (0)(0) + (-2)(-1) + (3)(4) & (1)(-1) + (0)(2) + (-2)(3) + (3)(2) \\ (2)(5) + (1)(0) + (4)(-1) + (-1)(4) & (2)(-1) + (1)(2) + (4)(3) + (-1)(2) \end{bmatrix} = \begin{bmatrix} 19 & -1 \\ 2 & 10 \end{bmatrix}$$

$$\begin{aligned} \text{ (b) } BA &= \begin{bmatrix} (5)(1) + (-1)(2) & (5)(0) + (-1)(1) & (5)(-2) + (-1)(4) & (5)(3) + (-1)(-1) \\ (0)(1) + (2)(2) & (0)(0) + (2)(1) & (0)(-2) + (2)(4) & (0)(3) + (2)(-1) \\ (-1)(1) + (3)(2) & (-1)(0) + (3)(1) & (-1)(-2) + (3)(4) & (-1)(3) + (3)(-1) \\ (4)(1) + (2)(2) & (4)(0) + (2)(1) & (4)(-2) + (2)(4) & (4)(3) + (2)(-1) \end{bmatrix} \\ &= \begin{bmatrix} 3 & -1 & -14 & 16 \\ 4 & 2 & 8 & -2 \\ 5 & 3 & 14 & -6 \\ 8 & 2 & 0 & 10 \end{bmatrix} \end{aligned}$$

$$15. \text{ (a) } \begin{bmatrix} -3 \\ 1 \\ 4 \end{bmatrix}$$

$$\text{ (b) } \begin{bmatrix} -1 \\ 1 \\ -4 \end{bmatrix}$$

$$\text{ (c) } \begin{bmatrix} -6 \\ 3 \\ 0 \end{bmatrix}$$

$$\begin{aligned} \text{ (d) } 2A - 3B &= 2 \begin{bmatrix} -2 \\ 1 \\ 0 \end{bmatrix} - 3 \begin{bmatrix} -1 \\ 0 \\ 4 \end{bmatrix} = \begin{bmatrix} -4 \\ 2 \\ 0 \end{bmatrix} - \begin{bmatrix} -3 \\ 0 \\ 12 \end{bmatrix} \\ &= \begin{bmatrix} -1 \\ 2 \\ -12 \end{bmatrix} \end{aligned}$$

$$16. \text{ (a) } [0 \ 0 \ -2 \ 3]$$

$$\text{ (b) } [-2 \ -4 \ 2 \ 3]$$

$$\text{ (c) } [-3 \ -6 \ 0 \ 9]$$

$$\begin{aligned} \text{ (d) } 2A - 3B &= 2[-1 \ -2 \ 0 \ 3] - 3[1 \ 2 \ -2 \ 0] \\ &= [-2 \ -4 \ 0 \ 6] - [3 \ 6 \ -6 \ 0] \\ &= [-5 \ -10 \ 6 \ 6] \end{aligned}$$

$$\begin{aligned}
 \mathbf{21. (a) } AB &= \begin{bmatrix} (-1)(2) + (0)(-1) + (2)(4) & (-1)(1) + (0)(0) + (2)(-3) & (-1)(0) + (0)(2) + (2)(-1) \\ (4)(2) + (1)(-1) + (-1)(4) & (4)(1) + (1)(0) + (-1)(-3) & (4)(0) + (1)(2) + (-1)(-1) \\ (2)(2) + (0)(-1) + (1)(4) & (2)(1) + (0)(0) + (1)(-3) & (2)(0) + (0)(2) + (1)(-1) \end{bmatrix} \\
 &= \begin{bmatrix} 6 & -7 & -2 \\ 3 & 7 & 3 \\ 8 & -1 & -1 \end{bmatrix}
 \end{aligned}$$

$$\begin{aligned}
 \mathbf{(b) } BA &= \begin{bmatrix} (2)(-1) + (1)(4) + (0)(2) & (2)(0) + (1)(1) + (0)(0) & (2)(2) + (1)(-1) + (0)(1) \\ (-1)(-1) + (0)(4) + (2)(2) & (-1)(0) + (0)(1) + (2)(0) & (-1)(2) + (0)(-1) + (2)(1) \\ (4)(-1) + (-3)(4) + (-1)(2) & (4)(0) + (-3)(1) + (-1)(0) & (4)(2) + (-3)(-1) + (-1)(1) \end{bmatrix} \\
 &= \begin{bmatrix} 2 & 1 & 3 \\ 5 & 0 & 0 \\ -18 & -3 & 10 \end{bmatrix}
 \end{aligned}$$

$$\begin{aligned}
 \mathbf{22. (a) } AB &= \begin{bmatrix} (-2)(4) + (3)(0) + (0)(-1) & (-2)(-1) + (3)(2) + (0)(3) & (-2)(2) + (3)(3) + (0)(-1) \\ (1)(4) + (-2)(0) + (4)(-1) & (1)(-1) + (-2)(2) + (4)(3) & (1)(2) + (-2)(3) + (4)(-1) \\ (3)(4) + (2)(0) + (1)(-1) & (3)(-1) + (2)(2) + (1)(3) & (3)(2) + (2)(3) + (1)(-1) \end{bmatrix} \\
 &= \begin{bmatrix} -8 & 8 & 5 \\ 0 & 7 & -8 \\ 11 & 4 & 11 \end{bmatrix}
 \end{aligned}$$

$$\begin{aligned}
 \mathbf{(b) } BA &= \begin{bmatrix} (4)(-2) + (-1)(1) + (2)(3) & (4)(3) + (-1)(-2) + (2)(2) & (4)(0) + (-1)(4) + (2)(1) \\ (0)(-2) + (2)(1) + (3)(3) & (0)(3) + (2)(-2) + (3)(2) & (0)(0) + (2)(4) + (3)(1) \\ (-1)(-2) + (3)(1) + (-1)(3) & (-1)(3) + (3)(-2) + (-1)(2) & (-1)(0) + (3)(4) + (-1)(1) \end{bmatrix} \\
 &= \begin{bmatrix} -3 & 18 & -2 \\ 11 & 2 & 11 \\ 2 & -11 & 11 \end{bmatrix}
 \end{aligned}$$

$$\mathbf{23. (a) } AB = [(2)(-5) + (-1)(4) + (3)(2)] = [-8]$$

$$\mathbf{(b) } BA = \begin{bmatrix} (-5)(2) & (-5)(-1) & (-5)(3) \\ (4)(2) & (4)(-1) & (4)(3) \\ (2)(2) & (2)(-1) & (2)(3) \end{bmatrix} = \begin{bmatrix} -10 & 5 & -15 \\ 8 & -4 & 12 \\ 4 & -2 & 6 \end{bmatrix}$$

$$\mathbf{24. (a) } AB = \begin{bmatrix} (-2)(-1) & (-2)(2) & (-2)(4) \\ (3)(-1) & (3)(2) & (3)(4) \\ (-4)(-1) & (-4)(2) & (-4)(4) \end{bmatrix} = \begin{bmatrix} 2 & -4 & -8 \\ -3 & 6 & 12 \\ 4 & -8 & -16 \end{bmatrix}$$

$$\mathbf{(b) } BA = [(-1)(-2) + (2)(3) + (4)(-4)] = [-8]$$

25. (a) AB is not possible.

$$\mathbf{(b) } BA = [(-3)(-1) + (5)(3) \quad (-3)(2) + (5)(4)] = [18 \ 14]$$

$$\mathbf{26. (a) } AB = \begin{bmatrix} (-1)(5) + (3)(2) & (-1)(-6) + (3)(3) \\ (0)(5) + (1)(2) & (0)(-6) + (1)(3) \\ (1)(5) + (0)(2) & (1)(-6) + (0)(3) \\ (-3)(5) + (-1)(2) & (-3)(-6) + (-1)(3) \end{bmatrix} = \begin{bmatrix} 1 & 15 \\ 2 & 3 \\ 5 & -6 \\ -17 & 15 \end{bmatrix}$$

(b) BA is not possible.

$$\mathbf{27. (a) } AB = \begin{bmatrix} (0)(1) + (0)(2) + (1)(-1) & (0)(2) + (0)(0) + (1)(3) & (0)(1) + (0)(1) + (1)(4) \\ (0)(1) + (1)(2) + (0)(-1) & (0)(2) + (1)(0) + (0)(3) & (0)(1) + (1)(1) + (0)(4) \\ (1)(1) + (0)(2) + (0)(-1) & (1)(2) + (0)(0) + (0)(3) & (1)(1) + (0)(1) + (0)(4) \end{bmatrix} = \begin{bmatrix} -1 & 3 & 4 \\ 2 & 0 & 1 \\ 1 & 2 & 1 \end{bmatrix}$$

$$\mathbf{(b) } BA = \begin{bmatrix} (1)(0) + (2)(0) + (1)(1) & (1)(0) + (2)(1) + (1)(0) & (1)(1) + (2)(0) + (1)(0) \\ (2)(0) + (0)(0) + (1)(1) & (2)(0) + (0)(1) + (1)(0) & (2)(1) + (0)(0) + (1)(0) \\ (-1)(0) + (3)(0) + (4)(1) & (-1)(0) + (3)(1) + (4)(0) & (-1)(1) + (3)(0) + (4)(0) \end{bmatrix} = \begin{bmatrix} 1 & 2 & 1 \\ 1 & 0 & 2 \\ 4 & 3 & -1 \end{bmatrix}$$

$$\mathbf{28. (a) } AB = \begin{bmatrix} 0 + 0 - 3 + 0 & 0 + 0 + 2 + 0 & 0 + 0 + 1 + 0 & 0 + 0 + 3 + 0 \\ 0 + 2 + 0 + 0 & 0 + 1 + 0 + 0 & 0 + 0 + 0 + 0 & 0 - 1 + 0 + 0 \\ -1 + 0 + 0 + 0 & 2 + 0 + 0 + 0 & 3 + 0 + 0 + 0 & -4 + 0 + 0 + 0 \\ 0 + 0 + 0 + 4 & 0 + 0 + 0 + 0 & 0 + 0 + 0 + 2 & 0 + 0 + 0 - 1 \end{bmatrix} = \begin{bmatrix} -3 & 2 & 1 & 3 \\ 2 & 1 & 0 & -1 \\ -1 & 2 & 3 & -4 \\ 4 & 0 & 2 & -1 \end{bmatrix}$$

$$\mathbf{(b) } BA = \begin{bmatrix} 0 + 0 + 3 + 0 & 0 + 2 + 0 + 0 & -1 + 0 + 0 + 0 & 0 + 0 + 0 - 4 \\ 0 + 0 + 0 + 0 & 0 + 1 + 0 + 0 & 2 + 0 + 0 + 0 & 0 + 0 + 0 - 1 \\ 0 + 0 + 1 + 0 & 0 + 2 + 0 + 0 & -3 + 0 + 0 + 0 & 0 + 0 + 0 + 3 \\ 0 + 0 + 2 + 0 & 0 + 0 + 0 + 0 & 4 + 0 + 0 + 0 & 0 + 0 + 0 - 1 \end{bmatrix} = \begin{bmatrix} 3 & 2 & -1 & -4 \\ 0 & 1 & 2 & -1 \\ 1 & 2 & -3 & 3 \\ 2 & 0 & 4 & -1 \end{bmatrix}$$

In #29–32, use the fact that two matrices are equal only if all entries are equal.

29. $a = 5, b = 2$

30. $a = 3, b = -1$

31. $a = -2, b = 0$

32. $a = 1, b = 6$

33. $AB = \begin{bmatrix} (2)(0.8) + (1)(-0.6) & (2)(-0.2) + (1)(0.4) \\ (3)(0.8) + (4)(-0.6) & (3)(-0.2) + (4)(0.4) \end{bmatrix} = \begin{bmatrix} 1 & 0 \\ 0 & 1 \end{bmatrix},$

$BA = \begin{bmatrix} (0.8)(2) + (-0.2)(3) & (0.8)(1) + (-0.2)(4) \\ (-0.2)(2) + (0.4)(3) & (0.6)(1) + (-0.4)(4) \end{bmatrix} = \begin{bmatrix} 1 & 0 \\ 0 & 1 \end{bmatrix},$ so A and B are inverses.

34. $AB = \begin{bmatrix} (-2)(0) + (1)(0.25) + 3(0.25) & (-2)(1) + (1)(0.5) + (3)(0.5) & (-2)(-2) + (1)(-0.25) + (3)(-1.25) \\ (1)(0) + (2)(0.25) + (-2)(0.25) & (1)(1) + (2)(0.5) + (-2)(0.5) & (1)(-2) + (2)(-0.25) + (-2)(-1.25) \\ (0)(0) + (1)(0.25) + (-1)(0.25) & (0)(1) + (1)(0.5) + (-1)(0.5) & (0)(-2) + (1)(-0.25) + (-1)(-1.25) \end{bmatrix}$
 $= \begin{bmatrix} 1 & 0 & 0 \\ 0 & 1 & 0 \\ 0 & 0 & 1 \end{bmatrix}$

$BA = \begin{bmatrix} (0)(-2) + (1)(1) + (-2)(0) & (0)(1) + (1)(2) + (-2)(1) \\ (0.25)(-2) + (0.5)(1) + (-0.25)(0) & (0.25)(1) + (0.5)(2) + (-0.25)(1) \\ (0.25)(-2) + (0.5)(1) + (-1.25)(0) & (0.25)(1) + (0.5)(2) + (-1.25)(1) \\ (0)(3) + (1)(-2) + (-2)(-1) \\ (0.25)(3) + (0.5)(-2) + (-0.25)(-1) \\ (0.25)(3) + (0.5)(-2) + (-1.25)(-1) \end{bmatrix}$
 $= \begin{bmatrix} 1 & 0 & 0 \\ 0 & 1 & 0 \\ 0 & 0 & 1 \end{bmatrix},$ so A and B are inverses.

35. $\begin{bmatrix} 2 & 3 \\ 2 & 2 \end{bmatrix}^{-1} = \frac{1}{(2)(2) - (2)(3)} \begin{bmatrix} 2 & -3 \\ -2 & 2 \end{bmatrix}$
 $= -\frac{1}{2} \begin{bmatrix} 2 & -3 \\ -2 & 2 \end{bmatrix} = \begin{bmatrix} -1 & 1.5 \\ 1 & -1 \end{bmatrix}$

36. No inverse: The determinant is $(6)(5) - (10)(3) = 0$.

37. No inverse: The determinant (found with a calculator) is 0.

38. Using a calculator: $\begin{bmatrix} 2 & 3 & -1 \\ -1 & 0 & 4 \\ 0 & 1 & 1 \end{bmatrix}^{-1}$
 $= \begin{bmatrix} 1 & 1 & -3 \\ -0.25 & -0.5 & 1.75 \\ 0.25 & 0.5 & -0.75 \end{bmatrix};$

to confirm, carry out the multiplication.

39. $A = \begin{bmatrix} 1 & -1 & 1 & -1 \\ -1 & 1 & -1 & 1 \\ 1 & -1 & 1 & -1 \\ -1 & 1 & -1 & 1 \end{bmatrix};$

No inverse, $\det(A) = 0$ (found using a calculator)

40. $B = \begin{bmatrix} 0 & 1 & 2 \\ 1 & 0 & 1 \\ 2 & 1 & 0 \end{bmatrix}$
 $B^{-1} = \begin{bmatrix} -0.25 & 0.5 & 0.25 \\ 0.5 & -1.0 & 0.5 \\ 0.25 & 0.5 & -0.25 \end{bmatrix}$

(found using a calculator, use multiplication to confirm)

41. Use row 2 or column 2 since they have the greatest number of zeros. Using column 2:

$\begin{vmatrix} 2 & 1 & 1 \\ -1 & 0 & 2 \\ 1 & 3 & -1 \end{vmatrix} = (1)(-1)^3 \begin{vmatrix} -1 & 2 \\ 1 & -1 \end{vmatrix}$
 $+ (0)(-1)^4 \begin{vmatrix} 2 & 1 \\ 1 & -1 \end{vmatrix} + (3)(-1)^5 \begin{vmatrix} 2 & 1 \\ -1 & 2 \end{vmatrix}$
 $= (-1)(1 - 2) + 0 + (-3)(4 + 1)$
 $= 1 + 0 - 15$
 $= -14$

42. Use row 1 or 4 or column 2 or 3 since they have the greatest number of zeros. Using column 3:

$\begin{vmatrix} 1 & 0 & 2 & 0 \\ 0 & 1 & 2 & 3 \\ 1 & -1 & 0 & 2 \\ 1 & 0 & 0 & 3 \end{vmatrix} = (2)(-1)^4 \begin{vmatrix} 0 & 1 & 3 \\ 1 & -1 & 2 \\ 1 & 0 & 3 \end{vmatrix}$
 $+ (2)(-1)^5 \begin{vmatrix} 1 & 0 & 0 \\ 1 & -1 & 2 \\ 1 & 0 & 3 \end{vmatrix} + 0 + 0$
 $= 2 \cdot \left[0 + 1(-1)^3 \begin{vmatrix} 1 & 3 \\ 0 & 3 \end{vmatrix} + 1(-1)^4 \begin{vmatrix} 1 & 3 \\ -1 & 2 \end{vmatrix} \right]$
 $- 2 \left[1(-1)^2 \begin{vmatrix} -1 & 2 \\ 0 & 3 \end{vmatrix} + 0 + 0 \right]$
 $= 2((-1)(3 - 0) + (1)(2 + 3)) - 2((1)(-3 - 0))$
 $= 2(-3 + 5) - 2(-3)$
 $= 4 + 6$
 $= 10$

43. $3X = B - A$

$$X = \frac{B - A}{3} = \frac{1}{3} \left(\begin{bmatrix} 4 \\ 2 \end{bmatrix} - \begin{bmatrix} 1 \\ 3 \end{bmatrix} \right) = \frac{1}{3} \begin{bmatrix} 3 \\ -1 \end{bmatrix} = \begin{bmatrix} 1 \\ -\frac{1}{3} \end{bmatrix}$$

44. $2X = B - A$

$$\begin{aligned} X &= \frac{B - A}{2} = \frac{1}{2} \left(\begin{bmatrix} 1 & 4 \\ 1 & -1 \end{bmatrix} - \begin{bmatrix} -1 & 2 \\ 0 & 3 \end{bmatrix} \right) \\ &= \frac{1}{2} \begin{bmatrix} 2 & 2 \\ 1 & -4 \end{bmatrix} \\ &= \begin{bmatrix} 1 & 1 \\ \frac{1}{2} & -2 \end{bmatrix} \end{aligned}$$

45. (a) The entries a_{ij} and a_{ji} are the same because each gives the distance between the same two cities.

(b) The entries a_{ii} are all 0 because the distance between a city and itself is 0.

46. $B = \begin{bmatrix} 1.1 \cdot 120 & 1.1 \cdot 70 \\ 1.1 \cdot 150 & 1.1 \cdot 110 \\ 1.1 \cdot 80 & 1.1 \cdot 160 \end{bmatrix} = \begin{bmatrix} 132 & 77 \\ 165 & 121 \\ 88 & 176 \end{bmatrix}$

$B = 1.1A$

47. (a) $B^T A = \begin{bmatrix} \$0.80 & \$0.85 & \$1.00 \end{bmatrix} \begin{bmatrix} 100 & 60 \\ 120 & 70 \\ 200 & 120 \end{bmatrix}$

$$\begin{bmatrix} 0.80(100) & 0.80(60) \\ + 0.85(120) & + 0.85(70) \\ 1(200) & + 1(120) \end{bmatrix} = \begin{bmatrix} 382 & 227.50 \end{bmatrix}$$

(b) b_{1j} in matrix $B^T A$ represents the income Happy Valley Farms makes at grocery store j , selling all three types of eggs.

48. (a) $SP = \begin{bmatrix} 16 & 10 & 8 & 12 \\ 12 & 0 & 10 & 14 \\ 4 & 12 & 0 & 8 \end{bmatrix} \begin{bmatrix} \$180 & \$269.99 \\ \$275 & \$399.99 \\ \$355 & \$499.99 \\ \$590 & \$799.99 \end{bmatrix}$

$$= \begin{bmatrix} \$15,550 & \$21,919.54 \\ \$8,070 & \$11,439.74 \\ \$8,740 & \$12,279.76 \end{bmatrix}$$

(b) The wholesale and retail values of all the inventory at store i are represented by a_{i1} and a_{i2} , respectively, in the matrix SP .

49. (a) Total revenue = sum of (price charged)(number sold) = AB^T or BA^T

(b) Profit = Total revenue - Total Cost = $AB^T - CB^T = (A - C)B^T$

50. (a) $B = \begin{bmatrix} 6 & 7 & 14 \end{bmatrix}$

(b) $BR = \begin{bmatrix} 6 & 7 & 14 \end{bmatrix} \begin{bmatrix} 5 & 22 & 14 & 7 & 17 \\ 7 & 20 & 10 & 9 & 21 \\ 6 & 27 & 8 & 5 & 13 \end{bmatrix}$

$$= \begin{bmatrix} 163 & 650 & 266 & 175 & 431 \end{bmatrix}$$

(c) $C = \begin{bmatrix} \$1,600 \\ \$ 900 \\ \$ 500 \\ \$ 100 \\ \$1,000 \end{bmatrix}$

(d) $RC = \begin{bmatrix} 5 & 22 & 14 & 7 & 17 \\ 7 & 20 & 10 & 9 & 21 \\ 6 & 27 & 8 & 5 & 13 \end{bmatrix} \begin{bmatrix} \$1,600 \\ \$ 900 \\ \$ 500 \\ \$ 100 \\ \$1,000 \end{bmatrix}$

$$= \begin{bmatrix} \$52,500 \\ \$56,100 \\ \$51,400 \end{bmatrix}$$

(e) $BRC = (BR)C$

$$= \begin{bmatrix} 163 & 650 & 266 & 175 & 431 \end{bmatrix} \begin{bmatrix} \$1,600 \\ \$ 900 \\ \$ 500 \\ \$ 100 \\ \$1,000 \end{bmatrix} = \begin{bmatrix} \$1,427,300 \end{bmatrix}$$

This is the building contractor's total cost of building all 27 houses.

51. (a) $\begin{bmatrix} x' & y' \end{bmatrix} = \begin{bmatrix} x & y \end{bmatrix} \begin{bmatrix} \cos \alpha & -\sin \alpha \\ \sin \alpha & \cos \alpha \end{bmatrix}$,

$x, y = 1, \alpha = 30^\circ$

$$= \begin{bmatrix} 1 & 1 \end{bmatrix} \begin{bmatrix} \frac{\sqrt{3}}{2} & -\frac{1}{2} \\ \frac{1}{2} & \frac{\sqrt{3}}{2} \end{bmatrix}$$

$$= \begin{bmatrix} \frac{\sqrt{3} + 1}{2} & \frac{\sqrt{3} - 1}{2} \end{bmatrix} \approx \begin{bmatrix} 1.37 & 0.37 \end{bmatrix}$$

(b) $\begin{bmatrix} x & y \end{bmatrix} = \begin{bmatrix} x' & y' \end{bmatrix} \begin{bmatrix} \cos \alpha & \sin \alpha \\ -\sin \alpha & \cos \alpha \end{bmatrix}$,

$x', y' = 1, \alpha = 30^\circ$

$$= \begin{bmatrix} 1 & 1 \end{bmatrix} \begin{bmatrix} \frac{\sqrt{3}}{2} & \frac{1}{2} \\ -\frac{1}{2} & \frac{\sqrt{3}}{2} \end{bmatrix}$$

$$= \begin{bmatrix} \frac{\sqrt{3} - 1}{2} & \frac{\sqrt{3} + 1}{2} \end{bmatrix} \approx \begin{bmatrix} 0.37 & 1.37 \end{bmatrix}$$

52. Answers will vary. One possible answer is given.

(a) $A + B = [a_{ij} + b_{ij}] = [b_{ij} + a_{ij}] = B + A$

(b) $(A + B) + C = [a_{ij} + b_{ij}] + C = [a_{ij} + b_{ij} + c_{ij}] = [a_{ij} + (b_{ij} + c_{ij})] = A + [b_{ij} + c_{ij}] = A + (B + C)$

(c) $A(B + C) = A[b_{ij} + c_{ij}] = \left[\sum_k a_{ik}(b_{kj} + c_{kj}) \right]$

(following the rules of matrix multiplication)

$$= \left[\sum_k (a_{ik}b_{kj} + a_{ik}c_{kj}) \right]$$

$$= \left[\sum_k a_{ik}b_{kj} + \sum_k a_{ik}c_{kj} \right]$$

$$= \left[\sum_k a_{ik}b_{kj} \right] + \left[\sum_k a_{ik}c_{kj} \right] = AB + AC$$

$$\begin{aligned}
 \text{(d)} \quad (A - B)C &= [a_{ij} - b_{ij}]C = \left[\sum_k (a_{ik} - b_{ik})c_{ki} \right] \\
 &= \left[\sum_k (a_{ik}c_{ki} + b_{ik}c_{ki}) \right] \\
 &= \left[\sum_k a_{ik}c_{ki} - \sum_k b_{ik}c_{ki} \right] \\
 &= \left[\sum_k a_{ik}c_{ki} \right] - \left[\sum_k b_{ik}c_{ki} \right] \\
 &= AC - BC
 \end{aligned}$$

53. Answers will vary. One possible answer is provided for each.

(a) $c(A + B) = c[a_{ij} + b_{ij}] = [ca_{ij} + cb_{ij}] = cA + cB$

(b) $(c + d)A = (c + d)[a_{ij}] = c[a_{ij}] + d[a_{ij}] = cA + dA$

(c) $c(dA) = c[da_{ij}] = [cda_{ij}] = cd[a_{ij}] = cdA$

(d) $1 \cdot A = 1 \cdot [a_{ij}] = [a_{ij}] = A$

54. One possible answer: If the definition of determinant is followed, the evaluation of the determinant of any $n \times n$ square matrix ($n > 2$) eventually involves the evaluation of a number of 2×2 sub-determinants. The determinant of the 2×2 matrix serves as the building block for all other determinants.

$$\begin{aligned}
 56. \quad AI_n &= \begin{bmatrix} a_{11} & a_{12} & \dots & a_{1n} \\ a_{21} & a_{22} & \dots & a_{2n} \\ \vdots & \vdots & & \vdots \\ a_{n1} & a_{n2} & \dots & a_{nn} \end{bmatrix} \begin{bmatrix} 1 & 0 & \dots & 0 \\ 0 & 1 & \dots & 0 \\ \vdots & \vdots & \ddots & \vdots \\ 0 & 0 & \dots & 1 \end{bmatrix} \\
 &= \begin{bmatrix} a_{11} + 0 \cdot a_{12} + \dots + 0 \cdot a_{1n} & 0 \cdot a_{11} + a_{12} + 0 \cdot a_{13} + \dots + 0 \cdot a_{1n} & \dots & 0 \cdot a_{11} + 0 \cdot a_{12} + \dots + a_{1n} \\ a_{21} + 0 \cdot a_{22} + \dots + 0 \cdot a_{2n} & 0 \cdot a_{21} + a_{22} + 0 \cdot a_{23} + \dots + 0 \cdot a_{2n} & \dots & 0 \cdot a_{21} + 0 \cdot a_{22} + \dots + a_{2n} \\ \vdots & \vdots & & \vdots \\ a_{n1} + 0 \cdot a_{n2} + \dots + 0 \cdot a_{nn} & 0 \cdot a_{n1} + a_{n2} + 0 \cdot a_{n3} + \dots + 0 \cdot a_{nn} & \dots & 0 \cdot a_{n1} + 0 \cdot a_{n2} + \dots + a_{nn} \end{bmatrix} \\
 &= \begin{bmatrix} a_{11} & a_{12} & \dots & a_{1n} \\ a_{21} & a_{22} & \dots & a_{2n} \\ \vdots & \vdots & & \vdots \\ a_{n1} & a_{n2} & \dots & a_{nn} \end{bmatrix} = A
 \end{aligned}$$

Use a similar process to show that $I_n A = A$.

57. If (x, y) is reflected across the y -axis, then

$$(x, y) \Rightarrow (-x, y).$$

$$\begin{bmatrix} x' & y' \end{bmatrix} = \begin{bmatrix} x & y \end{bmatrix} \begin{bmatrix} -1 & 0 \\ 0 & 1 \end{bmatrix}$$

58. If (x, y) is reflected across the line $y = x$, then

$$(x, y) \Rightarrow (y, x).$$

$$\begin{bmatrix} x' & y' \end{bmatrix} = \begin{bmatrix} x & y \end{bmatrix} \begin{bmatrix} 0 & 1 \\ 1 & 0 \end{bmatrix}$$

59. If (x, y) is reflected across the line $y = -x$, then

$$(x, y) \Rightarrow (-y, -x).$$

$$\begin{bmatrix} x' & y' \end{bmatrix} = \begin{bmatrix} x & y \end{bmatrix} \begin{bmatrix} 0 & -1 \\ -1 & 0 \end{bmatrix}$$

60. If (x, y) is vertically stretched (or shrunk) by a factor of a , then $(x, y) \Rightarrow (x, ay)$.

$$\begin{bmatrix} x' & y' \end{bmatrix} = \begin{bmatrix} x & y \end{bmatrix} \begin{bmatrix} 1 & 0 \\ 0 & a \end{bmatrix}$$

$$\begin{aligned}
 55. \quad A \cdot A^{-1} &= \begin{bmatrix} a & b \\ c & d \end{bmatrix} \left(\frac{1}{ad - bc} \right) \begin{bmatrix} d & -b \\ -c & a \end{bmatrix} \\
 &= \left(\frac{1}{ad - bc} \right) \begin{bmatrix} a & b \\ c & d \end{bmatrix} \begin{bmatrix} d & -b \\ -c & a \end{bmatrix} \\
 &\text{(since } \frac{1}{ad - bc} \text{ is a scalar)} \\
 &= \left(\frac{1}{ad - bc} \right) \begin{bmatrix} ad - bc & -ab + ba \\ cd - cd & -bc + ad \end{bmatrix} = \left(\frac{1}{ad - bc} \right)
 \end{aligned}$$

$$\begin{aligned}
 &\begin{bmatrix} ad - bc & 0 \\ 0 & ad - bc \end{bmatrix} \\
 &= \begin{bmatrix} \frac{ad - bc}{ad - bc} & 0 \\ 0 & \frac{ad - bc}{ad - bc} \end{bmatrix} \\
 &= \begin{bmatrix} 1 & 0 \\ 0 & 1 \end{bmatrix} = I_2
 \end{aligned}$$

61. If (x, y) is horizontally stretched (or shrunk) by a factor of c , then $(x, y) \Rightarrow (cx, y)$.

$$\begin{bmatrix} x' & y' \end{bmatrix} = \begin{bmatrix} x & y \end{bmatrix} \begin{bmatrix} c & 0 \\ 0 & 1 \end{bmatrix}$$

62. False. A square matrix A has an inverse if and only if $\det A \neq 0$.

63. False. The determinant can be negative. For example, the

$$\text{determinant of } A = \begin{bmatrix} 1 & 0 \\ 2 & -1 \end{bmatrix} \text{ is } 1(-1) - 2(0) = -1.$$

64. $2(-1) - (-3)(4) = 10$. The answer is C.

65. The matrix AB has the same number of rows as A and the same number of columns as B . The answer is B.

66. $\begin{bmatrix} 2 & 7 \\ 1 & 4 \end{bmatrix}^{-1} = \frac{1}{2(4) - 1(7)} \begin{bmatrix} 4 & -7 \\ -1 & 2 \end{bmatrix} = \begin{bmatrix} 4 & -7 \\ -1 & 2 \end{bmatrix}$
The answer is E.

67. The value in row 1, column 3 is 3. The answer is D.

68. (a) Recall that A_{ij} is $(-1)^{i+j}M_{ij}$ where M_{ij} is the determinant of the matrix obtained by deleting the row and column containing a_{ij} . Let $A = 3 \times 3$ square matrix. Then:

$$\det(A) = \begin{vmatrix} a_{11} & a_{12} & a_{13} \\ a_{21} & a_{22} & a_{23} \\ a_{31} & a_{32} & a_{33} \end{vmatrix}$$

$$= a_{11}A_{11} + a_{12}A_{12} + a_{13}A_{13}$$

$$= a_{11}|A_{11}| - a_{12}|A_{12}| + a_{13}|A_{13}|$$

Now let B be the matrix A with rows 1 and 2 interchanged. Then:

$$\det(B) = \begin{vmatrix} a_{21} & a_{22} & a_{23} \\ a_{11} & a_{12} & a_{13} \\ a_{31} & a_{32} & a_{33} \end{vmatrix}$$

$$= a_{11}B_{21} + a_{12}B_{22} + a_{13}B_{23}$$

$$= -a_{11}|A_{11}| + a_{12}|A_{12}| - a_{13}|A_{13}|$$

$$= (-1)(a_{11}|A_{11}| - a_{12}|A_{12}| + a_{13}|A_{13}|)$$

$$= -\det(A)$$

To generalize, we would say that by the definition of a determinant, the determinant of any $k \times k$ square matrix is ultimately dependent upon a series of 3×3 determinants. (In the 4×4 case, for example, we would have the expansion — using the first row — of $a_{11}A_{11} + a_{12}A_{12} + a_{13}A_{13} + a_{14}A_{14}$. If a row of matrix A is interchanged with another, the elements of all of matrix A 's 3×3 matrices will be affected, resulting in a sign change to the determinant.

- (b) Let A be a $k \times k$ square matrix with two rows exactly the same, and B be the matrix A with those exact same rows interchanged. From #4, we know that $\det(A) = -\det(B)$. However, since $A = B$ element-wise (i.e., $a_{ij} = b_{ij}$ for $1 \leq i, j \leq k$), we also know that $\det(A) = \det(B)$. These two properties can hold true only when $\det(A) = \det(B) = 0$.

- (c) Let $A = 3 \times 3$ square matrix. Then:

$$\det(A) = a_{11}a_{22}a_{33} - a_{11}a_{23}a_{32} - a_{12}a_{21}a_{33} + a_{12}a_{23}a_{31} + a_{13}a_{21}a_{32} - a_{13}a_{22}a_{31}$$

Now, let B be the 3×3 square matrix A , with the following exception: the first row of B is replaced with k times the second row of A plus the first row of A . Then:

$$\det(B) = \begin{vmatrix} a_{11} + ka_{21} & a_{12} + ka_{22} & a_{13} + ka_{23} \\ a_{21} & a_{22} & a_{23} \\ a_{31} & a_{32} & a_{33} \end{vmatrix}$$

$$= (a_{11} + ka_{21}) \begin{vmatrix} a_{22} & a_{23} \\ a_{32} & a_{33} \end{vmatrix} - (a_{12} + ka_{22}) \begin{vmatrix} a_{21} & a_{23} \\ a_{31} & a_{33} \end{vmatrix}$$

$$+ (a_{13} + ka_{23}) \begin{vmatrix} a_{21} & a_{22} \\ a_{31} & a_{32} \end{vmatrix}$$

$$= a_{11} \begin{vmatrix} a_{22} & a_{23} \\ a_{32} & a_{33} \end{vmatrix} + ka_{21} \begin{vmatrix} a_{22} & a_{23} \\ a_{32} & a_{33} \end{vmatrix} - a_{12} \begin{vmatrix} a_{21} & a_{23} \\ a_{31} & a_{33} \end{vmatrix}$$

$$- ka_{22} \begin{vmatrix} a_{21} & a_{23} \\ a_{31} & a_{33} \end{vmatrix} + a_{13} \begin{vmatrix} a_{21} & a_{22} \\ a_{31} & a_{32} \end{vmatrix} + ka_{23} \begin{vmatrix} a_{21} & a_{22} \\ a_{31} & a_{32} \end{vmatrix}$$

$$= a_{11}(a_{22}a_{33} - a_{23}a_{32}) - a_{12}(a_{21}a_{33} - a_{23}a_{31})$$

$$+ a_{13}(a_{21}a_{32} - a_{22}a_{31}) + ka_{21}(a_{22}a_{33} - a_{23}a_{32})$$

$$- ka_{22}(a_{21}a_{33} - a_{23}a_{31}) + ka_{23}(a_{21}a_{32} - a_{22}a_{31})$$

$$= a_{11}a_{22}a_{33} - a_{11}a_{23}a_{32} - a_{12}a_{21}a_{33} + a_{12}a_{23}a_{31}$$

$$+ a_{13}a_{21}a_{32} - a_{13}a_{22}a_{31} + ka_{21}a_{22}a_{33} - ka_{21}a_{23}a_{32}$$

$$- ka_{21}a_{22}a_{33} + ka_{22}a_{23}a_{31} + ka_{21}a_{22}a_{32} - ka_{22}a_{23}a_{31}$$

$$= a_{11}a_{22}a_{33} - a_{11}a_{23}a_{32} - a_{12}a_{21}a_{33} + a_{12}a_{23}a_{31}$$

$$+ a_{13}a_{21}a_{32} - a_{13}a_{22}a_{31} + 0$$

$$= \det(A).$$

This result holds in general.

69. (a) Let $A = [a_{ij}]$ be an $n \times n$ matrix and let B be the same as matrix A , except that the i th row of B is the i th row of A multiplied by the scalar c . Then:

$$\det(B) = \begin{vmatrix} a_{11} & a_{12} & \dots & a_{1n} \\ a_{21} & a_{22} & \dots & a_{2n} \\ \vdots & \vdots & \ddots & \vdots \\ ca_{i1} & ca_{i2} & \dots & ca_{in} \\ \vdots & \vdots & \ddots & \vdots \\ a_{n1} & a_{n2} & \dots & a_{nn} \end{vmatrix}$$

$$i\text{th row} \rightarrow \begin{vmatrix} ca_{i1} & ca_{i2} & \dots & ca_{in} \end{vmatrix}$$

$$= ca_{i1}(-1)^{i+1}|A_{i1}| + ca_{i2}(-1)^{i+2}|A_{i2}| + \dots$$

$$+ ca_{in}(-1)^{in}|A_{in}|$$

$$= c(a_{i1}(-1)^{i+1}|A_{i1}| + a_{i2}(-1)^{i+2}|A_{i2}| + \dots$$

$$+ a_{in}(-1)^{i+n}|A_{in}|)$$

$$= c \det(A) \text{ (by definition of determinant)}$$

- (b) Use the 2×2 case as an example

$$\det(A) = \begin{vmatrix} a_{11} & 0 \\ a_{21} & a_{22} \end{vmatrix} = a_{11}a_{22} - 0 = a_{11}a_{22}$$

which is the product of the diagonal elements.

Now consider the general case where A is an $n \times n$ matrix. Then:

$$\det(A) = \begin{vmatrix} a_{11} & 0 & 0 & \dots & 0 \\ a_{21} & a_{22} & 0 & \dots & 0 \\ \vdots & \vdots & \vdots & \ddots & \vdots \\ a_{n1} & a_{n2} & \dots & \dots & a_{nn} \end{vmatrix}$$

$$= a_{11}(-1)^2 \begin{vmatrix} a_{22} & 0 & 0 & \dots & 0 \\ a_{32} & a_{33} & 0 & \dots & 0 \\ \vdots & \vdots & \vdots & \ddots & \vdots \\ a_{n2} & a_{n3} & a_{n4} & \dots & a_{nn} \end{vmatrix}$$

$$= a_{11}(a_{22})(-1)^2 \begin{vmatrix} a_{33} & 0 & \dots & 0 \\ a_{43} & a_{44} & \dots & 0 \\ \vdots & \vdots & \ddots & \vdots \\ a_{n3} & a_{n4} & \dots & a_{nn} \end{vmatrix}$$

$$= a_{11}a_{22} \dots a_{n-2}a_{n-2}(-1)^2 \begin{vmatrix} a_{n-1} & a_{n-1} & 0 \\ a_n & a_n & a_{nn} \end{vmatrix}$$

$$= a_{11}a_{22} \dots a_{n-2}a_{n-2}a_{n-1}a_{n-1}a_{nn}, \text{ which is exactly the product of the diagonal elements (by induction).}$$

70. (a)
$$\begin{vmatrix} 1 & x & y \\ 1 & x_1 & y_1 \\ 1 & x_2 & y_2 \end{vmatrix} = 1(-1)^2 \begin{vmatrix} x_1 & y_1 \\ x_2 & y_2 \end{vmatrix} + x(-1)^3 \begin{vmatrix} 1 & y_1 \\ 1 & y_2 \end{vmatrix}$$

$$+ y(-1)^4 \begin{vmatrix} 1 & x_1 \\ 1 & x_2 \end{vmatrix}$$

$$= (x_1y_2 - y_1x_2) - x(y_2 - y_1) + y(x_2 - x_1)$$
 Since $(y_2 - y_1)$ is not a power of x and $(x_2 - x_1)$ is not a power of y , the equation is linear.

- (b) If $(x, y) = (x_1, y_1)$, then $\det(A)$
 $= x_1y_2 - x_2y_1 - x_1y_2 + x_1y_1 + x_2y_1 - x_1y_1$
 $= 0$, so (x_1, y_1) lies on the line.
 If $(x, y) = (x_2, y_2)$, then, $\det(A)$
 $= x_1y_2 - x_2y_1 - x_2y_2 + x_2y_1 + x_2y_2 - x_1y_2 = 0$,
 so (x_2, y_2) lies on the line.

(c)
$$\begin{vmatrix} 1 & x_3 & y_3 \\ 1 & x_1 & y_1 \\ 1 & x_2 & y_2 \end{vmatrix} = 0$$

(d)
$$\begin{vmatrix} 1 & x_3 & y_3 \\ 1 & x_1 & y_1 \\ 1 & x_2 & y_2 \end{vmatrix} \neq 0$$

71. (a)
$$A \cdot A^{-1} = \begin{bmatrix} \cos \alpha & -\sin \alpha \\ \sin \alpha & \cos \alpha \end{bmatrix} \begin{bmatrix} \cos \alpha & \sin \alpha \\ -\sin \alpha & \cos \alpha \end{bmatrix}$$

$$= \begin{bmatrix} \cos^2 \alpha + \sin^2 \alpha & \sin \alpha \cos \alpha - \sin \alpha \cos \alpha \\ \sin \alpha \cos \alpha - \sin \alpha \cos \alpha & \sin^2 \alpha + \cos^2 \alpha \end{bmatrix} = \begin{bmatrix} 1 & 0 \\ 0 & 1 \end{bmatrix} = I_2$$

- (b) From the diagram, we know that:
 $x = r \cos \theta$ $y = r \sin \theta$
 $x' = r \cos(\theta - \alpha)$ $y' = r \sin(\theta - \alpha)$
 or $\cos(\theta - \alpha) = \frac{x'}{r}$ $\sin(\theta - \alpha) = \frac{y'}{r}$
- From algebra, we know that:
 $x = r \cos(\theta + \alpha - \alpha) = r \cos(\alpha + (\theta - \alpha))$ and
 $y = r \sin(\theta + \alpha - \alpha) = r \sin(\alpha + (\theta - \alpha))$

Using the trigonometric properties and substitution, we have:

$$\begin{aligned} x &= r(\cos \alpha \cos(\theta - \alpha) - \sin \alpha \sin(\theta - \alpha)) \\ &= r \cos \alpha \cos(\theta - \alpha) - r \sin \alpha \sin(\theta - \alpha) \\ &= (r \cos \alpha) \left(\frac{x'}{r} \right) - (r \sin \alpha) \left(\frac{y'}{r} \right) \\ &= x' \cos \alpha - y' \sin \alpha \\ y &= r(\sin \alpha \cos(\theta - \alpha) + \cos \alpha \sin(\theta - \alpha)) \\ &= r \sin \alpha \cos(\theta - \alpha) + r \cos \alpha \sin(\theta - \alpha) \\ &= (r \sin \alpha) \left(\frac{x'}{r} \right) + (r \cos \alpha) \left(\frac{y'}{r} \right) \\ &= x' \sin \alpha + y' \cos \alpha. \end{aligned}$$

(c)
$$\begin{bmatrix} x & y \end{bmatrix} = \begin{bmatrix} x' & y' \end{bmatrix} \begin{bmatrix} \cos \alpha & \sin \alpha \\ -\sin \alpha & \cos \alpha \end{bmatrix}$$

 which is $\begin{bmatrix} x' & y' \end{bmatrix} A^{-1}$, the inverse of A .

72. (a)
$$\det(xI_2 - A) = \det \begin{bmatrix} x - a_{11} & -a_{12} \\ -a_{21} & x - a_{22} \end{bmatrix}$$

$$= (x - a_{11})(x - a_{22}) - (a_{12})(a_{21})$$

$$= x^2 - a_{22}x - a_{11}x + a_{11}a_{22} - a_{12}a_{21}$$

$$= x^2 + (-a_{22} - a_{11})x + (a_{11}a_{22} - a_{12}a_{21})$$

 $f(x)$ is a polynomial of degree 2.

- (b) They are equal.
 (c) The coefficient of x is the opposite of the sum of the elements of the main diagonal in A .
 (d) $f(A) = \det(AI - A) = \det(A - A)$
 $= \det([0]) = 0$.

73.
$$\det(xI_3 - A) = \begin{vmatrix} x - a_{11} & -a_{12} & -a_{13} \\ -a_{21} & x - a_{22} & -a_{23} \\ -a_{31} & -a_{32} & x - a_{33} \end{vmatrix}$$

$$= (x - a_{11})(-1)^2 \begin{vmatrix} x - a_{22} & -a_{23} \\ -a_{32} & x - a_{33} \end{vmatrix}$$

$$+ (-a_{12})(-1)^3 \begin{vmatrix} -a_{21} & -a_{23} \\ -a_{31} & x - a_{33} \end{vmatrix}$$

$$+ (-a_{13})(-1)^4 \begin{vmatrix} -a_{21} & x - a_{22} \\ -a_{31} & -a_{32} \end{vmatrix}$$

$$= (x - a_{11})((x - a_{22})(x - a_{33}) - a_{23}a_{32})$$

$$+ a_{12}((-a_{21})(x - a_{33}) - a_{23}a_{31})$$

$$- a_{13}(a_{21}a_{32} + (a_{31})(x - a_{22}))$$

$$= (x - a_{11})(x^2 - a_{33}x - a_{22}x + a_{22}a_{33} - a_{23}a_{32})$$

$$+ a_{12}(-a_{21}x + a_{21}a_{33} - a_{23}a_{31})$$

$$- a_{13}(a_{21}a_{32} + a_{31}x - a_{22}a_{31})$$

$$= x^3 - a_{33}x^2 - a_{22}x^2 + a_{22}a_{33}x - a_{23}a_{32}x - a_{11}x^2$$

$$+ a_{11}a_{33}x + a_{11}a_{22}x - a_{11}a_{22}a_{33} + a_{11}a_{23}a_{32} - a_{12}a_{21}x$$

$$+ a_{12}a_{21}a_{33} - a_{12}a_{23}a_{31} - a_{13}a_{21}a_{32} - a_{13}a_{31}x$$

$$+ a_{13}a_{22}a_{31}$$

$$= x^3 + (-a_{33} - a_{22} - a_{11})x^2 + (a_{22}a_{33} - a_{23}a_{32} + a_{11}a_{33}$$

$$+ a_{11}a_{22} - a_{12}a_{21} - a_{13}a_{31})x + (-a_{11}a_{22}a_{33} + a_{11}a_{23}a_{32}$$

$$+ a_{12}a_{21}a_{33} - a_{12}a_{23}a_{31} - a_{13}a_{21}a_{32} + a_{13}a_{22}a_{31})$$

- (b) The constant term equals $-\det(A)$.
 (c) The coefficient of x^2 is the opposite of the sum of the elements of the main diagonal in A .
 (d) $f(A) = \det(AI - A) = \det(A - A)$
 $= \det([0]) = 0$

Section 7.3 Multivariate Linear Systems and Row Operations

Exploration 1

- $x + y + z$ must equal the total number of liters in the mixture, namely 60 L.
- $0.15x + 0.35y + 0.55z$ must equal total amount of acid in the mixture; since the mixture must be 40% acid and have 60 L of solution, the total amount of acid must be $0.40(60) = 24$ L.
- The number of liters of 35% solution, y , must equal twice the number of liters of 55% solution, z . Hence $y = 2z$.

4.
$$\begin{bmatrix} 1 & 1 & 1 \\ 0.15 & 0.35 & 0.55 \\ 0 & 1 & -2 \end{bmatrix} \begin{bmatrix} x \\ y \\ z \end{bmatrix} = \begin{bmatrix} 60 \\ 24 \\ 0 \end{bmatrix}$$

$$A = \begin{bmatrix} 1 & 1 & 1 \\ 0.15 & 0.35 & 0.55 \\ 0 & 1 & -2 \end{bmatrix}, X = \begin{bmatrix} x \\ y \\ z \end{bmatrix}, B = \begin{bmatrix} 60 \\ 24 \\ 0 \end{bmatrix}$$

$$5. X = A^{-1}B = \begin{bmatrix} 3.75 \\ 37.5 \\ 18.75 \end{bmatrix}$$

6. 3.75 L of 15% acid, 37.5 L of 35% acid, and 18.75 L of 55% acid are required to make 60 L of a 40% acid solution.

Quick Review 7.3

- $(40)(0.32) = 12.8$ liters
- $(60)(0.14) = 8.4$ milliliters
- $(50)(1 - 0.24) = 38$ liters
- $(80)(1 - 0.70) = 24$ milliliters
- $(-1, 6)$
- $(0, -1)$
- $y = w - z + 1$
- $x = 2z - w + 3$
- $\begin{bmatrix} 1 & 3 \\ -2 & -2 \end{bmatrix}^{-1} = \begin{bmatrix} -0.5 & -0.75 \\ 0.5 & 0.25 \end{bmatrix}$
- $\begin{bmatrix} 0 & 0 & 2 \\ -2 & 1 & 3 \\ 0 & 2 & -2 \end{bmatrix}^{-1} = \begin{bmatrix} 1 & -0.5 & 0.25 \\ 0.5 & 0 & 0.5 \\ 0.5 & 0 & 0 \end{bmatrix}$

Section 7.3 Exercises

- $x - 3y + z = 0$ (1)
 $2y + 3z = 1$ (2)
 $z = -2$ (3)

Use $z = -2$ in equation (2).

$$\begin{aligned} 2y + 3(-2) &= 1 \\ 2y &= 7 \\ y &= \frac{7}{2} \end{aligned}$$

Use $z = -2, y = 7/2$ in equation (1).

$$\begin{aligned} x - 3\left(\frac{7}{2}\right) + (-2) &= 0 \\ x &= \frac{25}{2} \end{aligned}$$

So the solution is $(25/2, 7/2, -2)$.

- $3x - y + 2z = -2$ (1)
 $y + 3z = 3$ (2)
 $2z = 4$ (3)

From equation (3), $z = 2$. Use this in equation (2).

$$\begin{aligned} y + 3(2) &= 3 \\ y &= -3 \end{aligned}$$

Use $z = 2, y = -3$ in equation (1).

$$\begin{aligned} 3x - (-3) + 2(2) &= -2 \\ 3x &= -9 \\ x &= -3 \end{aligned}$$

So the solution is $(-3, -3, 2)$.

- $x - y + z = 0$
 $2x - 3z = -1$
 $-x - y + 2z = -1$
 $x - y + z = 0$
 $-2y + z = -3$
 $-x - y + 2z = -1$
 $x - y + z = 0$
 $-2y + z = -3$
 $-2y + 3z = -1$

$$\begin{aligned} x - y + z &= 0 \\ -2y + z &= -3 \\ 2z &= 2 \end{aligned} \begin{array}{l} \swarrow -1(-2y + z = -3) \\ \searrow -2y + 3z = -1 \end{array}$$

$$\begin{aligned} x - y + z &= 0 \\ y - \frac{1}{2}z &= \frac{3}{2} \end{array} \begin{array}{l} \xrightarrow{-\frac{1}{2}(-2y + z = -3)} \\ \xrightarrow{\frac{1}{2}(2z = 2)} \end{array}$$

$$\begin{aligned} y - \frac{1}{2}(1) &= \frac{3}{2}; y = 2 \\ x - 2 + 1 &= 0; x = 1 \end{aligned}$$

The solution is $(1, 2, 1)$.

- $2x - y = 0$
 $x + 3y - z = -3$
 $3y + z = 8$
 $-7y + 2z = 6$
 $x + 3y - z = -3$
 $3y + z = 8$
 $\frac{13}{3}z = \frac{74}{3}$
 $x + 3y - z = -3$
 $3y + z = 8$
 $x + 3y - z = -3$
 $y + \frac{1}{3}z = \frac{8}{3}$
 $z = \frac{74}{13}$

$$y + \frac{1}{3}\left(\frac{74}{13}\right) = \frac{8}{3}; y = \frac{10}{13}$$

$$x + 3\left(\frac{10}{13}\right) - \frac{74}{13} = -3; x = \frac{5}{13}$$

The solution is $(5/13, 10/13, 74/13)$.

- $x + y + z = -3$
 $4x - y = -5$
 $-3x + 2y + z = 4$
 $x + y + z = -3$
 $4x - y = -5$
 $-4x + y = 7$
 $x + y + z = -3$
 $4x - y = -5$
 $0 = 2$

The system has no solution.

- $x + y - 3z = -1$
 $2x - 3y + z = 4$
 $3x - 7y + 5z = 4$
 $x + y - 3z = -1$
 $-5y + 7z = 6$
 $3x - 7y + 5z = 4$
 $x + y - 3z = -1$
 $-5y + 7z = 6$
 $-10y + 14z = 7$
 $x + y - 3z = -1$
 $-5y + 7z = 6$
 $0 = -5$

The system has no solution.

$$\begin{aligned}
 7. \quad & x + y - z = 4 \\
 & y + w = -4 \\
 & x - y = 1 \\
 & x + z + w = 1 \\
 & 2y - z = 3 \\
 & y + w = -4 \\
 & x - y = 1 \\
 & x + z + w = 1 \\
 & 2y - z = 3 \\
 & y + w = -4 \\
 & x - y = 1 \\
 & y + z + w = 0 \\
 & -z - 2w = 11 \\
 & y + w = -4 \\
 & x - y = 1 \\
 & y + z + w = 0 \\
 & -z - 2w = 11 \\
 & y + w = -4 \\
 & x - y = 1 \\
 & z = 4 \\
 & x - y = 1 \\
 & y + w = -4 \\
 & w + \frac{1}{2}z = -\frac{11}{2} \quad \text{---} \quad -\frac{1}{2}(-z - 2w = 11) \\
 & z = 4
 \end{aligned}$$

$$\begin{aligned}
 w + \frac{1}{2}(4) &= -\frac{11}{2}; w = -\frac{15}{2} \\
 y + \left(-\frac{15}{2}\right) &= -4; y = \frac{7}{2} \\
 x - \frac{7}{2} &= 1; x = \frac{9}{2} \\
 \text{So the solution is } &\left(\frac{9}{2}, \frac{7}{2}, 4, -\frac{15}{2}\right).
 \end{aligned}$$

$$\begin{aligned}
 8. \quad & \frac{1}{2}x - y + z - w = 1 \\
 & -x + y + z + 2w = -3 \\
 & x - z = 2 \\
 & y + w = 0
 \end{aligned}$$

$$\begin{aligned}
 & \frac{1}{2}x - y + z - w = 1 \\
 & y + 2w = -1 \begin{cases} -x + y + z + 2w = -3 \\ x - z = 2 \end{cases} \\
 & x - z = 2 \\
 & y + w = 0 \\
 & \frac{1}{2}x - y + z - w = 1 \\
 & w = -1 \begin{cases} y + 2w = -1 \\ -1(y + w = 0) \end{cases} \\
 & x - z = 2 \\
 & y + w = 0 \\
 & -y + \frac{3}{2}z - w = 0 \begin{cases} \frac{1}{2}x - y + z - w = 1 \\ -\frac{1}{2}(x - z = 2) \end{cases} \\
 & w = -1 \\
 & x - z = 2 \\
 & y + w = 0 \\
 & x - z = 2 \\
 & z - \frac{2}{3}y - \frac{2}{3}w = 0 \quad \text{---} \quad \frac{2}{3}(-y + \frac{3}{2}z - w = 0) \\
 & y + w = 0 \\
 & w = -1
 \end{aligned}$$

$$\begin{aligned}
 y + (-1) &= 0; y = 1 \\
 z - \frac{2}{3}(1) - \frac{2}{3}(-1) &= 0; z = 0 \\
 x - 0 &= 2; x = 2 \\
 \text{So the solution is } &(2, 1, 0, -1).
 \end{aligned}$$

9. $\begin{bmatrix} 2 & -6 & 4 \\ 1 & 2 & -3 \\ 0 & -8 & 4 \end{bmatrix}$

10. $\begin{bmatrix} 1 & -3 & 2 \\ 1 & 2 & -3 \\ -3 & 1 & -2 \end{bmatrix}$

11. $\begin{bmatrix} 0 & -10 & 10 \\ 1 & 2 & -3 \\ -3 & 1 & -2 \end{bmatrix}$

12. $\begin{bmatrix} 2 & -6 & 4 \\ 3 & -4 & 1 \\ -3 & 1 & -2 \end{bmatrix}$

- 13. R_{12}
- 14. $(2)R_2 + R_1$
- 15. $(-3)R_2 + R_3$
- 16. $(1/4)R_3$

For #17–20, answers will vary depending on the exact sequence of row operations used. One possible sequence of row operations (not necessarily the shortest) is given. The answers shown are not necessarily the ones that might be produced by a grapher or other technology. In some cases, they are not the ones given in the text answers.

17. $\begin{bmatrix} 1 & 3 & -1 \\ 2 & 1 & 4 \\ -3 & 0 & 1 \end{bmatrix} \xrightarrow{\substack{(-2)R_1 + R_2 \\ (3)R_1 + R_3}} \begin{bmatrix} 1 & 3 & -1 \\ 0 & -5 & 6 \\ 0 & 9 & -2 \end{bmatrix} \xrightarrow{\substack{(9/5)R_2 + R_3 \\ (-1/5)R_2}} \begin{bmatrix} 1 & 3 & -1 \\ 0 & 1 & -1.2 \\ 0 & 0 & 8.8 \end{bmatrix} \xrightarrow{(5/44)R_3} \begin{bmatrix} 1 & 3 & -1 \\ 0 & 1 & -1.2 \\ 0 & 0 & 1 \end{bmatrix}$

18. $\begin{bmatrix} 1 & 2 & -3 \\ -3 & -6 & 10 \\ -2 & -4 & 7 \end{bmatrix} \xrightarrow{\substack{(3)R_1 + R_2 \\ (2)R_1 + R_3}} \begin{bmatrix} 1 & 2 & -3 \\ 0 & 0 & 1 \\ 0 & 0 & 1 \end{bmatrix} \xrightarrow{(-1)R_2 + R_3} \begin{bmatrix} 1 & 2 & -3 \\ 0 & 0 & 1 \\ 0 & 0 & 0 \end{bmatrix}$

$$19. \begin{bmatrix} 1 & 2 & 3 & -4 \\ -2 & 6 & -6 & 2 \\ 3 & 12 & 6 & 12 \end{bmatrix} \xrightarrow[\begin{smallmatrix} (-3)R_1 + R_3 \end{smallmatrix}]{\begin{smallmatrix} (2)R_1 + R_2 \end{smallmatrix}} \begin{bmatrix} 1 & 2 & 3 & -4 \\ 0 & 10 & 0 & -6 \\ 0 & 6 & -3 & 24 \end{bmatrix} \xrightarrow[\begin{smallmatrix} (-1/3)R_3 \end{smallmatrix}]{\begin{smallmatrix} (1/10)R_2 \end{smallmatrix}} \begin{bmatrix} 1 & 2 & 3 & -4 \\ 0 & 1 & 0 & -0.6 \\ 0 & -2 & 1 & -8 \end{bmatrix} \xrightarrow{\begin{smallmatrix} (2)R_2 + R_3 \end{smallmatrix}} \begin{bmatrix} 1 & 2 & 3 & -4 \\ 0 & 1 & 0 & -0.6 \\ 0 & 0 & 1 & -9.2 \end{bmatrix}$$

$$20. \begin{bmatrix} 3 & 6 & 9 & -6 \\ 2 & 5 & 5 & -3 \end{bmatrix} \xrightarrow{(1/3)R_1} \begin{bmatrix} 1 & 2 & 3 & -2 \\ 2 & 5 & 5 & -3 \end{bmatrix} \xrightarrow{(-2)R_1 + R_2} \begin{bmatrix} 1 & 2 & 3 & -2 \\ 0 & 1 & -1 & 1 \end{bmatrix}$$

In #21–24, reduced row echelon format is essentially unique, though the sequence of steps may vary from those shown.

$$21. \begin{bmatrix} 1 & 0 & 2 & 1 \\ 3 & 2 & 4 & 7 \\ 2 & 1 & 3 & 4 \end{bmatrix} \xrightarrow[\begin{smallmatrix} (-2)R_1 + R_3 \end{smallmatrix}]{\begin{smallmatrix} (-3)R_1 + R_2 \end{smallmatrix}} \begin{bmatrix} 1 & 0 & 2 & 1 \\ 0 & 2 & -2 & 4 \\ 0 & 1 & -1 & 2 \end{bmatrix} \xrightarrow{(1/2)R_2} \begin{bmatrix} 1 & 0 & 2 & 1 \\ 0 & 1 & -1 & 2 \\ 0 & 1 & -1 & 2 \end{bmatrix} \xrightarrow{(-1)R_2 + R_3} \begin{bmatrix} 1 & 0 & 2 & 1 \\ 0 & 1 & -1 & 2 \\ 0 & 0 & 0 & 0 \end{bmatrix}$$

$$22. \begin{bmatrix} 1 & -2 & 2 & 1 & 1 \\ 3 & -5 & 6 & 3 & -1 \\ -2 & 4 & -3 & -2 & 5 \\ 3 & -5 & 6 & 4 & -3 \end{bmatrix} \xrightarrow[\begin{smallmatrix} (2)R_1 + R_3 \end{smallmatrix}]{\begin{smallmatrix} (-3)R_1 + R_2 \end{smallmatrix}} \begin{bmatrix} 1 & -2 & 2 & 1 & 1 \\ 0 & 1 & 0 & 0 & -4 \\ 0 & 0 & 1 & 0 & 7 \\ 3 & -5 & 6 & 4 & -3 \end{bmatrix} \xrightarrow[\begin{smallmatrix} (2)R_2 + R_1 \end{smallmatrix}]{\begin{smallmatrix} (-3)R_1 + R_4 \end{smallmatrix}} \begin{bmatrix} 1 & 0 & 2 & 1 & -7 \\ 0 & 1 & 0 & 0 & -4 \\ 0 & 0 & 1 & 0 & 7 \\ 0 & 1 & 0 & 1 & -6 \end{bmatrix}$$

$$\xrightarrow[\begin{smallmatrix} (-2)R_3 + R_1 \end{smallmatrix}]{\begin{smallmatrix} (-1)R_2 + R_4 \end{smallmatrix}} \begin{bmatrix} 1 & 0 & 0 & 1 & -21 \\ 0 & 1 & 0 & 0 & -4 \\ 0 & 0 & 1 & 0 & 7 \\ 0 & 0 & 0 & 1 & -2 \end{bmatrix} \xrightarrow{(-1)R_4 + R_1} \begin{bmatrix} 1 & 0 & 0 & 0 & -19 \\ 0 & 1 & 0 & 0 & -4 \\ 0 & 0 & 1 & 0 & 7 \\ 0 & 0 & 0 & 1 & -2 \end{bmatrix}$$

$$23. \begin{bmatrix} 1 & 2 & 3 & 1 \\ -3 & -5 & -7 & -4 \end{bmatrix} \xrightarrow{(3)R_1 + R_2} \begin{bmatrix} 1 & 2 & 3 & 1 \\ 0 & 1 & 2 & -1 \end{bmatrix} \xrightarrow{(-2)R_2 + R_1} \begin{bmatrix} 1 & 0 & -1 & 3 \\ 0 & 1 & 2 & -1 \end{bmatrix}$$

$$24. \begin{bmatrix} 3 & -6 & 3 & -3 \\ 2 & -4 & 2 & -2 \\ -3 & 6 & -3 & 3 \end{bmatrix} \xrightarrow{(1/3)R_1} \begin{bmatrix} 1 & -2 & 1 & -1 \\ 2 & -4 & 2 & -2 \\ -3 & 6 & -3 & 3 \end{bmatrix} \xrightarrow[\begin{smallmatrix} (3)R_1 + R_3 \end{smallmatrix}]{\begin{smallmatrix} (-2)R_1 + R_2 \end{smallmatrix}} \begin{bmatrix} 1 & -2 & 1 & -1 \\ 0 & 0 & 0 & 0 \\ 0 & 0 & 0 & 0 \end{bmatrix}$$

$$25. \begin{bmatrix} 2 & -3 & 1 & 1 \\ -1 & 1 & -4 & -3 \\ 3 & 0 & -1 & 2 \end{bmatrix}$$

$$26. \begin{bmatrix} 3 & -4 & 1 & -1 & 1 \\ 1 & 0 & 1 & -2 & 4 \end{bmatrix}$$

$$27. \begin{bmatrix} 2 & -5 & 1 & -1 & -3 \\ 1 & 0 & -2 & 1 & 4 \\ 0 & 2 & -3 & -1 & 5 \end{bmatrix}$$

$$28. \begin{bmatrix} 3 & -2 & 5 \\ -1 & 5 & 7 \end{bmatrix}$$

In #29–32, the variable names (x , y , etc.) are arbitrary.

$$29. \begin{aligned} 3x + 2y &= -1 \\ -4x + 5y &= 2 \end{aligned}$$

$$30. \begin{aligned} x - z + 2w &= -3 \\ 2x + y - w &= 4 \\ -x + y + 2z &= 0 \end{aligned}$$

$$31. \begin{aligned} 2x + z &= 3 \\ -x + y &= 2 \\ 2y - 3z &= -1 \end{aligned}$$

$$32. \begin{aligned} 2x + y - 2z &= 4 \\ -3x + 2z &= -1 \end{aligned}$$

$$33. \begin{bmatrix} 1 & -2 & 1 & 8 \\ 2 & 1 & -3 & -9 \\ -3 & 1 & 3 & 5 \end{bmatrix} \xrightarrow[\begin{smallmatrix} (3)R_1 + R_3 \end{smallmatrix}]{\begin{smallmatrix} (-2)R_1 + R_2 \end{smallmatrix}} \begin{bmatrix} 1 & -2 & 1 & 8 \\ 0 & 5 & -5 & -25 \\ 0 & -5 & 6 & 29 \end{bmatrix} \xrightarrow[\begin{smallmatrix} (1/5)R_2 \end{smallmatrix}]{\begin{smallmatrix} (1)R_2 + R_3 \end{smallmatrix}} \begin{bmatrix} 1 & -2 & 1 & 8 \\ 0 & 1 & -1 & -5 \\ 0 & 0 & 1 & 4 \end{bmatrix}$$

$$x - 2y + z = 8$$

$$y - z = -5$$

$$z = 4$$

$$y - 4 = -5; y = -1$$

$$x - 2(-1) + 4 = 8; x = 2$$

So the solution is $(2, -1, 4)$.

$$34. \begin{bmatrix} 3 & 7 & -11 & 44 \\ 1 & 2 & -3 & 12 \\ 4 & 9 & -13 & 53 \end{bmatrix} \xrightarrow{\substack{(-3)R_2 + R_1 \\ (-4)R_2 + R_3}} \begin{bmatrix} 0 & 1 & -2 & 8 \\ 1 & 2 & -3 & 12 \\ 0 & 1 & -1 & 5 \end{bmatrix} \xrightarrow{\substack{(-1)R_1 + R_3 \\ R_{12}}} \begin{bmatrix} 1 & 2 & -3 & 12 \\ 0 & 1 & -2 & 8 \\ 0 & 0 & 1 & -3 \end{bmatrix}$$

$$x + 2y - 3z = 12$$

$$y - 2z = 8$$

$$z = -3$$

$$y - 2(-3) = 8; y = 2$$

$$x + 2(2) - 3(-3) = 12; x = -1$$

So the solution is $(-1, 2, -3)$.

$$35. (x, y, z) = (-2, 3, 1): \begin{bmatrix} 1 & 2 & -1 & 3 \\ 3 & 7 & -3 & 12 \\ -2 & -4 & 3 & -5 \end{bmatrix} \xrightarrow{\substack{(-3)R_1 + R_2 \\ (2)R_1 + R_3}} \begin{bmatrix} 1 & 2 & -1 & 3 \\ 0 & 1 & 0 & 3 \\ 0 & 0 & 1 & 1 \end{bmatrix} \xrightarrow{\substack{(-2)R_2 + R_1 \\ (1)R_3 + R_1}} \begin{bmatrix} 1 & 0 & 0 & -2 \\ 0 & 1 & 0 & 3 \\ 0 & 0 & 1 & 1 \end{bmatrix}$$

$$36. (x, y, z) = (7, 6, 3): \begin{bmatrix} 1 & -2 & 1 & -2 \\ 2 & -3 & 2 & 2 \\ 4 & -8 & 5 & -5 \end{bmatrix} \xrightarrow{\substack{(-2)R_1 + R_2 \\ (-4)R_1 + R_3}} \begin{bmatrix} 1 & -2 & 1 & -2 \\ 0 & 1 & 0 & 6 \\ 0 & 0 & 1 & 3 \end{bmatrix} \xrightarrow{\substack{(2)R_2 + R_1 \\ (-1)R_3 + R_1}} \begin{bmatrix} 1 & 0 & 0 & 7 \\ 0 & 1 & 0 & 6 \\ 0 & 0 & 1 & 3 \end{bmatrix}$$

$$37. \text{No solution:} \begin{bmatrix} 1 & 1 & 3 & 2 \\ 3 & 4 & 10 & 5 \\ 1 & 2 & 4 & 3 \end{bmatrix} \xrightarrow{\substack{(-3)R_1 + R_2 \\ (-1)R_1 + R_3}} \begin{bmatrix} 1 & 1 & 3 & 2 \\ 0 & 1 & 1 & -1 \\ 0 & 1 & 1 & 1 \end{bmatrix} \xrightarrow{(-1)R_2 + R_3} \begin{bmatrix} 1 & 1 & 3 & 2 \\ 0 & 1 & 1 & -1 \\ 0 & 0 & 0 & 2 \end{bmatrix}$$

38. $(x, y, z) = (z + 2, -z - 1, z)$ — the final matrix translates to $x - z = 2$ and $y + z = -1$.

$$\begin{bmatrix} 1 & 0 & -1 & 2 \\ -2 & 1 & 3 & -5 \\ 2 & 1 & -1 & 3 \end{bmatrix} \xrightarrow{\substack{(2)R_1 + R_2 \\ (-2)R_1 + R_3}} \begin{bmatrix} 1 & 0 & -1 & 2 \\ 0 & 1 & 1 & -1 \\ 0 & 1 & 1 & -1 \end{bmatrix} \xrightarrow{(-1)R_2 + R_3} \begin{bmatrix} 1 & 0 & -1 & 2 \\ 0 & 1 & 1 & -1 \\ 0 & 0 & 0 & 0 \end{bmatrix}$$

39. $(x, y, z) = (2 - z, 1 + z, z)$ — the final matrix translates to $x + z = 2$ and $y - z = 1$.

$$\begin{bmatrix} 1 & 0 & 1 & 2 \\ 2 & 1 & 1 & 5 \end{bmatrix} \xrightarrow{(-2)R_1 + R_2} \begin{bmatrix} 1 & 0 & 1 & 2 \\ 0 & 1 & -1 & 1 \end{bmatrix}$$

40. $(x, y, z) = (z + 53, z - 26, z)$ — the final matrix translates to $x - z = 53$ and $y - z = -26$.

$$\begin{bmatrix} 1 & 2 & -3 & 1 \\ -3 & -5 & 8 & -29 \end{bmatrix} \xrightarrow{(3)R_1 + R_2} \begin{bmatrix} 1 & 2 & -3 & 1 \\ 0 & 1 & -1 & -26 \end{bmatrix} \xrightarrow{(-2)R_2 + R_1} \begin{bmatrix} 1 & 0 & -1 & 53 \\ 0 & 1 & -1 & -26 \end{bmatrix}$$

$$41. \text{No solution:} \begin{bmatrix} 1 & 2 & 4 \\ 3 & 4 & 5 \\ 2 & 3 & 4 \end{bmatrix} \xrightarrow{\substack{(-3)R_1 + R_2 \\ (-2)R_1 + R_3}} \begin{bmatrix} 1 & 2 & 4 \\ 0 & -2 & -7 \\ 0 & -1 & -4 \end{bmatrix} \xrightarrow{(1/2)R_2} \begin{bmatrix} 1 & 2 & 4 \\ 0 & -1 & -7/2 \\ 0 & -1 & -4 \end{bmatrix}$$

$$42. (x, y) = (1, 2): \begin{bmatrix} 1 & 1 & 3 \\ 2 & 3 & 8 \\ 2 & 2 & 6 \end{bmatrix} \xrightarrow{\substack{(-2)R_1 + R_2 \\ (-2)R_1 + R_3}} \begin{bmatrix} 1 & 1 & 3 \\ 0 & 1 & 2 \\ 0 & 0 & 0 \end{bmatrix} \xrightarrow{(-1)R_2 + R_1} \begin{bmatrix} 1 & 0 & 1 \\ 0 & 1 & 2 \\ 0 & 0 & 0 \end{bmatrix}$$

43. $(x, y, z) = (z + w + 2, 2z - w - 1, z, w)$ — the final matrix translates to $x - z - w = 2$ and $y - 2z + w = -1$.

$$\begin{bmatrix} 1 & 1 & -3 & 0 & 1 \\ 1 & 0 & -1 & -1 & 2 \\ 2 & 1 & -4 & -1 & 3 \end{bmatrix} \xrightarrow{\substack{(-1)R_2 + R_1 \\ (-2)R_2 + R_3}} \begin{bmatrix} 1 & 1 & -3 & 0 & 1 \\ 0 & 1 & -2 & 1 & -1 \\ 0 & 1 & -2 & 1 & -1 \end{bmatrix} \xrightarrow{\substack{(-1)R_1 + R_3 \\ R_{12}}} \begin{bmatrix} 1 & 0 & -1 & -1 & 2 \\ 0 & 1 & -2 & 1 & -1 \\ 0 & 0 & 0 & 0 & 0 \end{bmatrix}$$

44. $(x, y, z) = (z - w, w + 3, z, w)$ — the final matrix translates to $x - z + w = 0$ and $y - w = 3$.

$$\begin{bmatrix} 1 & -1 & -1 & 2 & -3 \\ 2 & -1 & -2 & 3 & -3 \\ 1 & -2 & -1 & 3 & -6 \end{bmatrix} \xrightarrow{\substack{(-2)R_1 + R_2 \\ (-1)R_1 + R_3}} \begin{bmatrix} 1 & -1 & -1 & 2 & -3 \\ 0 & 1 & 0 & -1 & 3 \\ 0 & -1 & 0 & 1 & -3 \end{bmatrix} \xrightarrow{\substack{(1)R_2 + R_1 \\ (1)R_2 + R_3}} \begin{bmatrix} 1 & 0 & -1 & 1 & 0 \\ 0 & 1 & 0 & -1 & 3 \\ 0 & 0 & 0 & 0 & 0 \end{bmatrix}$$

$$45. \begin{bmatrix} 2 & 5 \\ 1 & -2 \end{bmatrix} \begin{bmatrix} x \\ y \end{bmatrix} = \begin{bmatrix} -3 \\ 1 \end{bmatrix}$$

$$46. \begin{bmatrix} 5 & -7 & 1 \\ 2 & -3 & -1 \\ 1 & 1 & 1 \end{bmatrix} \begin{bmatrix} x \\ y \\ z \end{bmatrix} = \begin{bmatrix} 2 \\ 3 \\ -3 \end{bmatrix}$$

$$47. \begin{aligned} 3x - y &= -1 \\ 2x + 4y &= 3 \end{aligned}$$

$$48. \begin{aligned} x - 3z &= 3 \\ 2x - y + 3z &= -1 \\ -2x + 3y - 4z &= 2 \end{aligned}$$

49. $(x, y) = (-2, 3)$:

$$\begin{bmatrix} x \\ y \end{bmatrix} = \begin{bmatrix} 2 & -3 \\ 4 & 1 \end{bmatrix}^{-1} \begin{bmatrix} -13 \\ -5 \end{bmatrix} = \frac{1}{14} \begin{bmatrix} 1 & 3 \\ -4 & 2 \end{bmatrix} \begin{bmatrix} -13 \\ -5 \end{bmatrix} = \frac{1}{14} \begin{bmatrix} -28 \\ 42 \end{bmatrix} = \begin{bmatrix} -2 \\ 3 \end{bmatrix}.$$

50. $(x, y) = (1, -1.5)$:

$$\begin{bmatrix} x \\ y \end{bmatrix} = \begin{bmatrix} 1 & 2 \\ 3 & -4 \end{bmatrix}^{-1} \begin{bmatrix} -2 \\ 9 \end{bmatrix} = -\frac{1}{10} \begin{bmatrix} -4 & -2 \\ -3 & 1 \end{bmatrix} \begin{bmatrix} -2 \\ 9 \end{bmatrix} = -\frac{1}{10} \begin{bmatrix} -10 \\ 15 \end{bmatrix} = \begin{bmatrix} 1 \\ -1.5 \end{bmatrix}.$$

51. $(x, y, z) = (-2, -5, -7)$; $\begin{bmatrix} x \\ y \\ z \end{bmatrix} = \begin{bmatrix} 2 & -1 & 1 \\ 1 & 2 & -3 \\ 3 & -2 & 1 \end{bmatrix}^{-1} \begin{bmatrix} -6 \\ 9 \\ -3 \end{bmatrix} = \begin{bmatrix} -2 \\ -5 \\ -7 \end{bmatrix}$

52. $(x, y, z) = (3, -0.5, 0.5)$; $\begin{bmatrix} x \\ y \\ z \end{bmatrix} = \begin{bmatrix} 1 & 4 & -2 \\ 2 & 1 & 1 \\ -3 & 3 & -5 \end{bmatrix}^{-1} \begin{bmatrix} 0 \\ 6 \\ -13 \end{bmatrix} = \begin{bmatrix} 3 \\ -0.5 \\ 0.5 \end{bmatrix}$

53. $(x, y, z, w) = (-1, 2, -2, 3)$; $\begin{bmatrix} x \\ y \\ z \\ w \end{bmatrix} = \begin{bmatrix} 2 & -1 & 1 & 1 \\ 1 & 2 & -3 & 1 \\ 3 & -1 & -1 & 2 \\ -2 & 3 & 1 & -3 \end{bmatrix}^{-1} \begin{bmatrix} -3 \\ 12 \\ 3 \\ -3 \end{bmatrix} = \begin{bmatrix} -1 \\ 2 \\ -2 \\ 3 \end{bmatrix}$

54. $(x, y, z, w) = (4, -2, 1, -3)$; $\begin{bmatrix} x \\ y \\ z \\ w \end{bmatrix} = \begin{bmatrix} 2 & 1 & 2 & 0 \\ 3 & 2 & -1 & -1 \\ -2 & 1 & 0 & -3 \\ 4 & -3 & 2 & -5 \end{bmatrix}^{-1} \begin{bmatrix} 8 \\ 10 \\ -1 \\ 39 \end{bmatrix} = \begin{bmatrix} 4 \\ -2 \\ 1 \\ -3 \end{bmatrix}$

55. $(x, y, z) = (0, -10, 1)$: Solving up from the bottom gives $z = 1$; then $y - 2 = -12$, so $y = -10$; then $2x + 10 = 10$, so $x = 0$.

$$\begin{array}{lll} 2x - y = 10 & 2x - y = 10 & 2x - y = 10 \\ x - z = -1 \Rightarrow 2\mathbf{E}_2 - \mathbf{E}_1 \Rightarrow & y - 2z = -12 & y - 2z = -12 \\ y + z = -9 & y + z = -9 \Rightarrow \mathbf{E}_3 - \mathbf{E}_2 \Rightarrow & 3z = 3 \end{array}$$

56. $(x, y, z) = (-2, 0, 0.5)$: Solving up from the bottom gives $z = 0.5$;

then $y - (5.5)(0.5) = 247 - 2.75$, so $y = 0$; then $1.25x + 0.5 = -2$, so $x = -2$.

$$\begin{array}{ll} 1.25x + z = -2 & 1.25x + z = -2 \\ y - 5.5z = -2.75 & y - 5.5z = -2.75 \\ 3x - 1.5y = -6 \Rightarrow \mathbf{E}_3 - 2.4\mathbf{E}_1 + 1.5\mathbf{E}_2 \Rightarrow & -10.65z = -5.325 \end{array}$$

57. $(x, y, z, w) = (3, 3, -2, 0)$: Solving up from the bottom gives $w = 0$; then $-z + 0 = 2$, so $z = -2$; then $-3y + 4 = -5$, so $y = 3$; then $x + 6 - 4 = 5$, so $x = 3$.

$$\begin{array}{lll} x + 2y + 2z + w = 5 & x + 2y + 2z + w = 5 & \\ 2x + y + 2z = 5 \Rightarrow \mathbf{E}_2 - 2\mathbf{E}_1 \Rightarrow & -3y - 2z - 2w = -5 & \\ 3x + 3y + 3z + 2w = 12 \Rightarrow \mathbf{E}_3 - 3\mathbf{E}_1 \Rightarrow & -3y - 3z - w = -3 \Rightarrow \mathbf{E}_3 - \mathbf{E}_2 \Rightarrow & \\ x + z + w = 1 \Rightarrow \mathbf{E}_4 - \mathbf{E}_1 \Rightarrow & -2y - z = -4 \Rightarrow 3\mathbf{E}_4 - 2\mathbf{E}_2 \Rightarrow & \\ x + 2y + 2z + w = 5 & x + 2y + 2z + w = 5 & \\ -3y - 2z - 2w = -5 & -3y - 2z - 2w = -5 & \\ -z + w = 2 & -z + w = 2 & \\ z + 4w = -2 \Rightarrow \mathbf{E}_4 + \mathbf{E}_3 \Rightarrow & 5w = 0 & \end{array}$$

58. $(x, y, z, w) = (-1, 2, 4, -1)$: Solving up from the bottom gives $w = -1$; then $-z + 2 = -2$, so $z = 4$; then $-y + 4 - 2 = 0$, so $y = 2$; then $x - 2 - 1 = -4$, so $x = -1$.

$$\begin{array}{lll} x - y + w = -4 & x - y + w = -4 & x - y + w = -4 \\ -2x + y + z = 8 \Rightarrow \mathbf{E}_2 + 2\mathbf{E}_1 \Rightarrow & -y + z + 2w = 0 & -y + z + 2w = 0 \\ 2x - 2y - z = -10 \Rightarrow \mathbf{E}_3 - 2\mathbf{E}_1 \Rightarrow & -z - 2w = -2 & -z - 2w = -2 \\ -2x + z + w = 5 \Rightarrow \mathbf{E}_4 + 2\mathbf{E}_1 \Rightarrow & -2y + z + 3w = -3 \Rightarrow \mathbf{E}_4 - 2\mathbf{E}_2 - \mathbf{E}_3 \Rightarrow & w = -1 \end{array}$$

59. $(x, y, z) = \left(2 - \frac{3}{2}z, -\frac{1}{2}z - 4, z\right)$: z can be anything; once z is chosen, we have $2y + z = -8$, so $y = -\frac{1}{2}z - 4$; then

$$\begin{array}{ll} x - \left(-\frac{1}{2}z - 4\right) + z = 6, \text{ so } x = 2 - \frac{3}{2}z & \\ x - y + z = 6 & x - y + z = 6 \\ x + y + 2z = -2 \Rightarrow \mathbf{E}_2 - \mathbf{E}_1 \Rightarrow & 2y + z = -8 \end{array}$$

60. $(x, y, z) = \left(\frac{1}{5}z - 1, \frac{3}{5}z - 2, z\right)$: z can be anything; once z is chosen, we have $5y - 3z = -10$, so $y = \frac{3}{5}z - 2$; then

$$x - 2\left(\frac{3}{5}z - 2\right) + z = 3, \text{ so } x = \frac{1}{5}z - 1.$$

$$\begin{array}{rcl} x - 2y + z = 3 & & x - 2y + z = 3 \\ 2x + y - z = -4 \Rightarrow \mathbf{E}_2 - 2\mathbf{E}_1 \Rightarrow & & 5y - 3z = -10 \end{array}$$

61. $(x, y, z, w) = (-1 - 2w, w + 1, -w, w)$: w can be anything; once w is chosen, we have $-z - w = 0$, so $z = -w$; then $y - w = 1$, so $y = w + 1$; then $x + (w + 1) + (-w) + 2w = 0$, so $x = -1 - 2w$.

$$\begin{array}{rcl} 2x + y + z + 4w = -1 \Rightarrow \mathbf{E}_1 - 2\mathbf{E}_3 \Rightarrow & & -y - z = -1 \Rightarrow \mathbf{E}_1 + \mathbf{E}_2 \Rightarrow & & -z - w = 0 \\ x + 2y + z + w = 1 \Rightarrow \mathbf{E}_2 - \mathbf{E}_3 \Rightarrow & & y - w = 1 & & y - w = 1 \\ x + y + z + 2w = 0 & & x + y + z + 2w = 0 & & x + y + z + 2w = 0 \end{array}$$

62. $(x, y, z, w) = (w, 1 - 2w, -w - 1, w)$: w can be anything; once w is chosen, we have $-z - w = 1$, so $z = -w - 1$; then $y + 2w = 1$, so $y = 1 - 2w$; then $x + (1 - 2w) + 2(-w - 1) + 3w = -1$, so $x = w$.

$$\begin{array}{rcl} 2x + 3y + 3z + 7w = 0 \Rightarrow \mathbf{E}_1 - 2\mathbf{E}_3 \Rightarrow & & y - z + w = 2 \Rightarrow \mathbf{E}_1 - \mathbf{E}_2 \Rightarrow & & -z - w = 1 \\ x + 2y + 2z + 5w = 0 \Rightarrow \mathbf{E}_2 - \mathbf{E}_3 \Rightarrow & & y + 2w = 1 & & y + 2w = 1 \\ x + y + 2z + 3w = -1 & & x + y + 2z + 3w = -1 & & x + y + 2z + 3w = -1 \end{array}$$

63. $(x, y, z, w) = (-w - 2, 0.5 - z, z, w)$: z and w can be anything; once they are chosen, we have $-y - z = -0.5$, so $y = 0.5 - z$; then since $y + z = 0.5$ we have $x + 0.5 + w = -1.5$, so $x = -w - 2$.

$$\begin{array}{rcl} 2x + y + z + 2w = -3.5 \Rightarrow \mathbf{E}_1 - 2\mathbf{E}_2 \Rightarrow & & -y - z = -0.5 \\ x + y + z + w = -1.5 & & x + y + z + w = -1.5 \end{array}$$

64. $(x, y, z, w) = (z - 3w + 1, 2w - 2z + 4, z, w)$: z and w can be anything; once they are chosen, we have $-y - 2z + 2w = -4$, so $y = 2w - 2z + 4$; then $x + (2w - 2z + 4) + z + w = 5$, so $x = z - 3w + 1$.

$$\begin{array}{rcl} 2x + y + 4w = 6 \Rightarrow \mathbf{E}_1 - 2\mathbf{E}_2 \Rightarrow & & -y - 2z + 2w = -4 \\ x + y + z + w = 5 & & x + y + z + w = 5 \end{array}$$

65. No solution: $\mathbf{E}_1 + \mathbf{E}_3$ gives $2x + 2y - z + 5w = 3$, which contradicts \mathbf{E}_4 .

66. $(x, y, z, w) = (1, 1 - w, 6w - 2, w)$: Note first that \mathbf{E}_4 is the same as \mathbf{E}_1 , so we ignore it. w can be anything, while $x = 1$. Once w is chosen, we have $1 + y + w = 2$, so $y = 1 - w$; then $2(1 - w) + z - 4w = 0$, so $z = 6w - 2$.

$$\begin{array}{rcl} x + y + w = 2 & & x + y + w = 2 & & x + y + w = 2 \\ x + 4y + z - 2w = 3 \Rightarrow \mathbf{E}_2 - \mathbf{E}_1 \Rightarrow & & 3y + z - 3w = 1 \Rightarrow \mathbf{E}_2 - \mathbf{E}_1 - \mathbf{E}_3 & & -x = -1 \\ x + 3y + z - 3w = 2 \Rightarrow \mathbf{E}_3 - \mathbf{E}_1 \Rightarrow & & 2y + z - 4w = 0 & & 2y + z - 4w = 0 \end{array}$$

67. $f(x) = 2x^2 - 3x - 2$: We have $f(-1) = a(-1)^2 + b(-1) + c = a - b + c = 3$, $f(1) = a + b + c = -3$, and $f(2) = 4a + 2b + c = 0$. Solving this system gives $(a, b, c) = (2, -3, -2)$.

$$\begin{array}{rcl} a - b + c = 3 & & a - b + c = 3 & & a - b + c = 3 \\ a + b + c = -3 \Rightarrow \mathbf{E}_2 - \mathbf{E}_1 \Rightarrow & & 2b = -6 & & 2b = -6 \\ 4a + 2b + c = 0 \Rightarrow \mathbf{E}_3 - 4\mathbf{E}_1 \Rightarrow & & 6b - 3c = -12 \Rightarrow \mathbf{E}_3 - 3\mathbf{E}_2 \Rightarrow & & -3c = 6 \end{array}$$

68. $f(x) = 3x^3 - x^2 + 2x - 5$: We have $f(-2) = -8a + 4b - 2c + d = -37$, $f(-1) = -a + b - c + d = -11$, $f(0) = d = -5$, and $f(2) = 8a + 4b + 2c + d = 19$. Solving this system gives $(a, b, c, d) = (3, -1, 2, -5)$.

$$\begin{array}{rcl} -8a + 4b - 2c + d = -37 & & -8a + 4b - 2c + d = -37 \Rightarrow \mathbf{E}_1 - 8\mathbf{E}_2 \Rightarrow & & -4b + 6c - 7d = 51 \\ -a + b - c + d = -11 & & -a + b - c + d = -11 & & -a + b - c + d = -11 \\ d = -5 & & d = -5 & & d = -5 \\ 8a + 4b + 2c + d = 19 \Rightarrow \mathbf{E}_4 - \mathbf{E}_1 \Rightarrow & & 8b + 2d = -18 & & 8b + 2d = -18 \end{array}$$

69. $f(x) = (-c - 3)x^2 + x + c$, for any c — or $f(x) = ax^2 + x + (-a - 3)$, for any a : We have $f(-1) = a - b + c = -4$ and $f(1) = a + b + c = -2$. Solving this system gives $(a, b, c) = (-c - 3, 1, c) = (a, 1, -a - 3)$. Note that when $c = -3$ (or $a = 0$), this is simply the line through $(-1, -4)$ and $(1, -2)$.

$$\begin{array}{rcl} a - b + c = -4 & & a - b + c = -4 \\ a + b + c = -2 \Rightarrow \mathbf{E}_2 - \mathbf{E}_1 \Rightarrow & & 2b = 2 \end{array}$$

70. $f(x) = (4 - c)x^3 - x^2 + cx - 1$, for any c — or $f(x) = ax^3 - x^2 + (4 - a)x - 1$, for any a : We have $f(-1) = -a + b - c + d = -6$, $f(0) = d = -1$, and $f(1) = a + b + c + d = 2$. Solving this system gives $(a, b, c, d) = (4 - c, -1, c, -1) = (a, -1, 4 - a, -1)$. Note that when $c = 4$ (or $a = 0$), this is simply the parabola through the given points.

$$\begin{array}{rcl} -a + b - c + d = -6 & & -a + b - c + d = -6 \\ d = -1 & & d = -1 \\ a + b + c + d = 2 \Rightarrow \mathbf{E}_3 + \mathbf{E}_1 \Rightarrow & & 2b + 2d = -4 \end{array}$$

71. In this problem, the graphs are representative of the population (in thousands) of the cities of Corpus Christi, TX, and Garland, TX, for several years, where x is the number of years past 1980.

(a) The following is a scatter plot of the Corpus Christi data with the linear regression equation $y = 2.0735x + 234.0268$ superimposed on it.

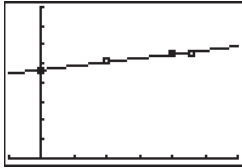

$[-3, 30]$ by $[0, 400]$

(b) The following is a scatter plot of the Garland data with the linear regression equation $y = 3.5302x + 141.7246$ superimposed on it.

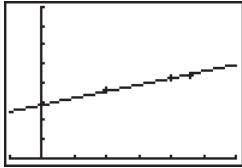

$[-3, 30]$ by $[0, 400]$

(c) *Graphical solution:* Graph the two linear equations $y = 2.0735x + 234.0268$ and $y = 3.5302x + 141.7246$ on the same axis and find their point of intersection. The two curves intersect at $x \approx 63.4$. So, the population of the two cities will be the same sometime in the year 2043.

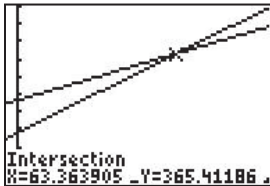

$[-5, 100]$ by $[0, 500]$

Another graphical solution would be to find where the graph of the difference of the two curves is equal to 0.

Algebraic solution:

$$\begin{aligned} \text{Solve } 2.0735x + 234.0268 &= 3.5302x + 141.7246 \text{ for } x. \\ 2.0735x + 234.0268 &= 3.5302x + 141.7246 \\ 1.4567x &= 92.3022 \\ x &= \frac{92.3022}{1.4567} \approx 63.4 \end{aligned}$$

The population of the two cities will be the same sometime in the year 2043.

72. In this problem, the graphs are representative of the population (in thousands) of the cities of Anaheim, CA, and Anchorage, AK, for several years, where x is the number of years past 1970.

(a) The following is a scatter plot of the Anaheim data with the linear regression equation $y = 5.1670x + 166.2935$ superimposed on it.

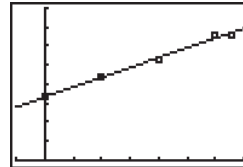

$[-3, 35]$ by $[0, 400]$

(b) The following is a scatter plot of the Anchorage data with the linear regression equation $y = 6.3140x + 78.3593$ superimposed on it.

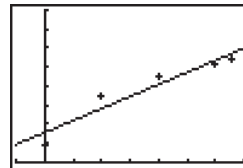

$[-3, 35]$ by $[0, 400]$

(c) *Graphical solution:* Graph the two linear equations $y = 5.1670x + 166.2935$ and $y = 6.3140x + 78.3593$ on the same axis and find their point of intersection. The two curves intersect at $x \approx 76.7$. The population of the two cities will be the same sometime in the year 2046.

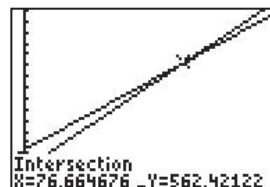

$[-5, 120]$ by $[0, 800]$

Another graphical solution would be to find where the graph of the difference of the two curves is equal to 0.

Algebraic solution:

$$\begin{aligned} \text{Solve } 5.1670x + 166.2935 &= 6.3140x + 78.3593 \text{ for } x. \\ 5.1670x + 166.2935 &= 6.3140x + 78.3593 \\ 1.147x &= 87.9342 \\ x &= \frac{87.9342}{1.147} \approx 76.7 \end{aligned}$$

The population of the two cities will be the same sometime in the year 2046.

73. $(x, y, z) = (825, 410, 165)$, where x is the number of children, y is the number of adults, and z is the number of senior citizens.

$$\begin{aligned} x + y + z &= 1400 & x + y + z &= 1400 \\ 25x + 100y + 75z &= 74,000 \Rightarrow \mathbf{E}_2 - 75\mathbf{E}_1 \Rightarrow & -50x + 25y &= -31,000 \\ x - y - z &= 250 \Rightarrow \mathbf{E}_3 + \mathbf{E}_1 \Rightarrow & 2x &= 1650 \end{aligned}$$

74. $(x, y, z) = \left(\frac{160}{11}, \frac{320}{11}, \frac{400}{11}\right) \approx (14.55, 29.09, 36.36)$ (all amounts in grams), where x is the amount of 22% alloy, y is the amount of 30% alloy, and z is the amount of 42% alloy.

$$\begin{array}{rcl} x + y + z = 80 & x + y + z = 80 & x + y + z = 80 \\ 0.22x + 0.30y + 0.42z = 27.2 \Rightarrow 50\mathbf{E}_2 - 11\mathbf{E}_1 \Rightarrow & 4y + 10z = 480 & 4y + 10z = 480 \\ 2x - y = 0 \Rightarrow \mathbf{E}_3 - 2\mathbf{E}_1 \Rightarrow & -3y - 2z = -160 \Rightarrow 4\mathbf{E}_3 + 3\mathbf{E}_2 \Rightarrow & 22z = 800 \end{array}$$

75. $(x, y, z) = (14,500, 5500, 60,000)$ (all amounts in dollars), where x is the amount invested in CDs, y is the amount in bonds, and z is the amount in the growth fund.

$$\begin{array}{rcl} x + y + z = 80,000 & x + y + z = 80,000 & \\ 0.067x + 0.093y + 0.156z = 10,843 \Rightarrow 1000\mathbf{E}_2 - 67\mathbf{E}_1 \Rightarrow & 26y + 89z = 5,483,000 & \\ 3x + 3y - z = 0 \Rightarrow \mathbf{E}_3 - 3\mathbf{E}_1 \Rightarrow & -4z = -240,000 & \end{array}$$

76. $(x, y, z) = (z - 9000, 29,000 - 2z, z)$ (all amounts in dollars). The amounts cannot be determined: if z dollars are invested at 10% ($9000 \leq z \leq 14,500$), then $z - 9000$ dollars invested at 6% and $29,000 - 2z$ invested at 8% satisfy all conditions.

$$\begin{array}{rcl} x + y + z = 20,000 & x + y + z = 20,000 & x + y + z = 20,000 \\ 0.06x + 0.08y + 0.10z = 1780 \Rightarrow 50\mathbf{E}_2 \Rightarrow & 3x + 4y + 5z = 89,000 \Rightarrow \mathbf{E}_2 - 3\mathbf{E}_1 \Rightarrow & y + 2z = 29,000 \\ -x + z = 9000 \Rightarrow \mathbf{E}_3 + 4\mathbf{E}_1 \Rightarrow & 3x + 4y + 5z = 89,000 & \end{array}$$

77. $(x, y, z) \approx (0, 38,983.05, 11,016.95)$: If z dollars are invested in the growth fund, then $y = \frac{1}{295}(21,250,000 - 885z) \approx$

$72,033.898 - 3z$ dollars must be invested in bonds, and $x \approx 2z - 22,033.898$ dollars are invested in CDs. Since $x \geq 0$, we see that $z \geq 11016.95$ (approximately); the minimum value of z requires that $x = 0$ (this is logical, since if we wish to minimize z , we should put the rest of our money in bonds, since bonds have a better return than CDs). Then $y \approx 72,033.898 - 3z = 38,983.05$.

$$\begin{array}{rcl} x + y + z = 50,000 & x + y + z = 50,000 & \\ 0.0575x + 0.087y + 0.146z = 5000 \Rightarrow 10,000\mathbf{E}_2 - 575\mathbf{E}_1 \Rightarrow & 295y + 885z = 21,250,000 & \end{array}$$

78. $(x, y, z) = (0, 28.8, 11.2)$: If z liters of the 50% solution are used, then $y = \frac{1}{15}(880 - 40z) = \frac{8}{3}(22 - z)$ liters of 25%

solution must be used, and $x = \frac{5}{3}z - \frac{56}{3}$ liters of 10% solution are needed. Since $x \geq 0$, we see that $z \geq 11.2$ liters;

the minimum value of z requires that $x = 0$. Then $y = \frac{8}{3}(22 - z) = 28.8$ liters.

$$\begin{array}{rcl} x + y + z = 40 & x + y + z = 40 & \\ 0.10x + 0.25y + 0.50z = 12.8 \Rightarrow 100\mathbf{E}_2 - 10\mathbf{E}_1 \Rightarrow & 15y + 40z = 880 & \end{array}$$

79. 22 nickels, 35 dimes, and 17 quarters:

$$\begin{array}{l} \left[\begin{array}{cccc} 1 & 1 & 1 & 74 \\ 5 & 10 & 25 & 885 \\ 1 & -1 & 1 & 4 \end{array} \right] \xrightarrow{\begin{array}{l} (-5)R_1 + R_2 \\ (-1)R_1 + R_3 \end{array}} \left[\begin{array}{cccc} 1 & 1 & 1 & 74 \\ 0 & 5 & 20 & 515 \\ 0 & -2 & 0 & -70 \end{array} \right] \xrightarrow{\begin{array}{l} R_{23} \\ (-1/2)R_2 \end{array}} \left[\begin{array}{cccc} 1 & 1 & 1 & 74 \\ 0 & 1 & 0 & 35 \\ 0 & 5 & 20 & 515 \end{array} \right] \xrightarrow{\begin{array}{l} (-1)R_2 + R_1 \\ (-5)R_2 + R_3 \end{array}} \\ \left[\begin{array}{cccc} 1 & 0 & 1 & 39 \\ 0 & 1 & 0 & 35 \\ 0 & 0 & 20 & 340 \end{array} \right] \xrightarrow{(1/20)R_3} \left[\begin{array}{cccc} 1 & 0 & 1 & 39 \\ 0 & 1 & 0 & 35 \\ 0 & 0 & 1 & 17 \end{array} \right] \xrightarrow{(-1)R_3 + R_1} \left[\begin{array}{cccc} 1 & 0 & 0 & 22 \\ 0 & 1 & 0 & 35 \\ 0 & 0 & 1 & 17 \end{array} \right] \end{array}$$

80. 27 one-dollar bills, 18 fives, and 6 tens:

$$\begin{array}{l} \left[\begin{array}{cccc} 1 & 1 & 1 & 51 \\ 1 & 5 & 10 & 177 \\ 0 & 1 & -3 & 0 \end{array} \right] \xrightarrow{\begin{array}{l} (-1)R_1 + R_2 \\ (-1)R_3 + R_1 \end{array}} \left[\begin{array}{cccc} 1 & 0 & 4 & 51 \\ 0 & 4 & 9 & 126 \\ 0 & 1 & -3 & 0 \end{array} \right] \xrightarrow{\begin{array}{l} (-4)R_3 + R_2 \\ R_{23} \end{array}} \left[\begin{array}{cccc} 1 & 0 & 4 & 51 \\ 0 & 1 & -3 & 0 \\ 0 & 0 & 21 & 126 \end{array} \right] \xrightarrow{(1/21)R_3} \\ \left[\begin{array}{cccc} 1 & 0 & 4 & 51 \\ 0 & 1 & -3 & 0 \\ 0 & 0 & 1 & 6 \end{array} \right] \xrightarrow{\begin{array}{l} (-4)R_3 + R_1 \\ (3)R_3 + R_2 \end{array}} \left[\begin{array}{cccc} 1 & 0 & 0 & 27 \\ 0 & 1 & 0 & 18 \\ 0 & 0 & 1 & 6 \end{array} \right] \end{array}$$

81. $(x, p) = \left(\frac{16}{3}, \frac{220}{3}\right)$: $\begin{bmatrix} x \\ p \end{bmatrix} = \begin{bmatrix} 5 & 1 \\ -10 & 1 \end{bmatrix}^{-1} \begin{bmatrix} 100 \\ 20 \end{bmatrix}$
 $= \frac{1}{15} \begin{bmatrix} 1 & -1 \\ 10 & 5 \end{bmatrix} \begin{bmatrix} 100 \\ 20 \end{bmatrix} = \frac{1}{15} \begin{bmatrix} 80 \\ 1100 \end{bmatrix} = \frac{1}{3} \begin{bmatrix} 16 \\ 220 \end{bmatrix}$

82. $(x, p) = \left(\frac{10}{3}, 110\right)$: $\begin{bmatrix} x \\ p \end{bmatrix} = \begin{bmatrix} 12 & 1 \\ -24 & 1 \end{bmatrix}^{-1} \begin{bmatrix} 150 \\ 30 \end{bmatrix}$
 $= \frac{1}{36} \begin{bmatrix} 1 & -1 \\ 24 & 12 \end{bmatrix} \begin{bmatrix} 150 \\ 30 \end{bmatrix} = \frac{1}{36} \begin{bmatrix} 120 \\ 3960 \end{bmatrix} = \frac{1}{3} \begin{bmatrix} 10 \\ 330 \end{bmatrix}$

83. Adding one row to another is the same as multiplying that first row by 1 and then adding it to the other, so that it falls into the category of the second type of elementary row operations. Also, it corresponds to adding one equation to another in the original system.

84. Subtracting one row from another is the same as multiplying that first row by -1 and then adding it to the other, so that it falls into the category of the second type of elementary row operations. Also, it corresponds to subtracting one equation from another.

85. False. For a nonzero square matrix to have an inverse, the determinant of the matrix must not be equal to zero.

86. False. The statement holds only for a system that has

$$\text{exactly one solution. For example, } \begin{bmatrix} 1 & 0 & 1 & 0 \\ 0 & 1 & 1 & 1 \\ 0 & 0 & 0 & 2 \end{bmatrix}$$

could be the reduced row echelon form for a system that has no solution.

90.
$$\begin{bmatrix} 1 & 2 & -1 & 8 \\ -1 & 3 & 2 & 3 \\ 2 & -1 & 3 & -19 \end{bmatrix} \xrightarrow{\substack{(1)R_1 + R_2 \\ (-2)R_1 + R_3}} \begin{bmatrix} 1 & 2 & -1 & 8 \\ 0 & 5 & 1 & 11 \\ 0 & -5 & 5 & -35 \end{bmatrix} \xrightarrow{\substack{(1)R_2 + R_3 \\ (1/6)R_3}} \begin{bmatrix} 1 & 2 & -1 & 8 \\ 0 & 5 & 1 & 11 \\ 0 & 0 & 1 & -4 \end{bmatrix} \xrightarrow{\substack{(-1)R_3 + R_2 \\ (1)R_3 + R_1}} \begin{bmatrix} 1 & 2 & 0 & 4 \\ 0 & 5 & 0 & 15 \\ 0 & 0 & 1 & -4 \end{bmatrix} \xrightarrow{\substack{(1/5)R_2 \\ (-2)R_2 + R_1}} \begin{bmatrix} 1 & 0 & 0 & -2 \\ 0 & 1 & 0 & 3 \\ 0 & 0 & 1 & -4 \end{bmatrix}$$

The answer is E.

91. (a) The planes can intersect at exactly one point

(b) At least two planes are parallel, or else the line of each pair of intersecting planes is parallel to the third plane.

(c) Two or more planes can coincide, or else all three planes can intersect along a single line.

92. Starting with any matrix in row echelon form, one can perform the operation $kR_i + R_j$, for any constant k , with $i > j$, and obtain another matrix in row echelon form. As

a simple example, $\begin{bmatrix} 1 & 1 & 1 \\ 0 & 1 & 1 \end{bmatrix}$ and $\begin{bmatrix} 1 & 2 & 2 \\ 0 & 1 & 1 \end{bmatrix}$ are two

equivalent matrices (the second can be obtained from the first via $R_2 + R_1$), both of which are in row echelon form.

93. (a) $C(x) = (x - 3)(x - 5) - (-1)(-2) = x^2 - 8x + 13.$

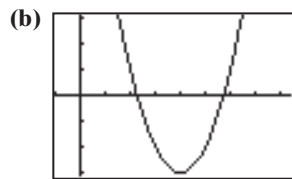

$[-1, 8.4]$ by $[-3.1, 3.1]$

(c) $C(x) = 0$ when $x = 4 \pm \sqrt{13}$ — approx. 2.27 and 5.73.

(d) $\det A = 13$, and the y -intercept is $(0, 13)$. This is the case because $C(0) = (3)(5) - (1)(2) = \det A$.

(e) $a_{11} + a_{22} = 3 + 5 = 8$. The eigenvalues add to $(4 - \sqrt{13}) + (4 + \sqrt{13}) = 8$, also.

94. (a) $C(x) = (x - 2)^2 - (-5)(-1) = x^2 - 4x - 1.$

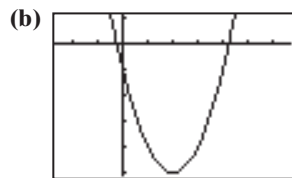

$[-2.7, 6.7]$ by $[-5.1, 1.1]$

(c) $C(x) = 0$ when $2 \pm \sqrt{5}$ — approx. -0.24 and 4.24 .

(d) $\det A = -1$, and the y -intercept is $(0, -1)$. This is the case because $C(0) = (2)(2) - (-5)(-1) = \det A$.

(e) $a_{11} + a_{22} = 2 + 2 = 4$. The eigenvalues add to $(2 - \sqrt{5}) + (2 + \sqrt{5}) = 4$, also.

87. $2(3) - (-1)(2) = 8$. The answer is D.

88. The augmented matrix has the variable coefficients in the first three columns and the constants in the last column. The answer is A.

89. Twice the first row was added to the second row. The answer is D.

Section 7.4 Partial Fractions

Exploration 1

1. (a) $25 - 1 = A_1(5 - 5) + A_2(5 + 3)$
 $24 = 8A_2$
 $3 = A_2$

(b) $-15 - 1 = A_1(-3 - 5) + A_2(-3 + 3)$
 $-16 = -8A_1$
 $2 = A_1$

2. (a) $-4 + 4 + 4 = A_1(2 - 2)^2 + 2A_2(2 - 2) + 2A_3$
 $4 = 2A_3$
 $2 = A_3$

(b) $0 + 0 + 4 = A_1(0 - 2)^2 + 0 \cdot A_2(0 - 2) + 0 \cdot A_3$
 $4 = 4A_1$
 $1 = A_1$

(c) Suppose $x = 3$
 $-9 + 6 + 4 = 1 \cdot (3 - 2)^2 + 2 \cdot 3(3 - 2) + 3A_2$
 $1 = 1 + 6 + 3A_2$
 $-6 = 3A_2$
 $-2 = A_2$

Quick Review 7.4

1. $\frac{(x - 3) + 2(x - 1)}{(x - 1)(x - 3)} = \frac{3x - 5}{(x - 1)(x - 3)}$
 $= \frac{3x - 5}{x^2 - 4x + 3}$

2. $\frac{5(x + 1) - 2(x + 4)}{(x + 4)(x + 1)} = \frac{3x - 3}{(x + 4)(x + 1)}$
 $= \frac{3(x - 1)}{x^2 + 5x + 4}$

3. $\frac{(x + 1)^2 + 3x(x + 1) + x}{x(x + 1)^2} = \frac{4x^2 + 6x + 1}{x(x + 1)^2}$
 $= \frac{4x^2 + 6x + 1}{x^3 + 2x^2 + x}$

4. $\frac{3(x^2 + 1) - (x + 1)}{(x^2 + 1)^2} = \frac{3x^2 - x + 2}{(x^2 + 1)^2}$

5.
$$\begin{array}{r} \begin{array}{cccc} -2 & 3 & -6 & -2 & 7 \\ & & -6 & 0 & 4 \\ \hline 3 & 0 & -2 & 3 & \end{array} \\ \frac{f(x)}{d(x)} = 3x^2 - 2 + \frac{3}{x - 2} \end{array}$$

$$6. \frac{2x + 1}{x^2 + x - 6} \frac{2x^3 + 3x^2 - 14x - 8}{2x^3 + 2x^2 - 12x} = \frac{x^2 - 2x - 8}{x^2 + x - 6} = \frac{-3x - 2}{-3x - 2}$$

$$\frac{f(x)}{d(x)} = 2x + 1 - \frac{3x + 2}{x^2 + x - 6}$$

7. Possible real rational zeros: $\pm 1, \pm 2, \pm 3, \pm 4, \pm 6, \pm 12$

± 1
From a graph, $x = -1$ and $x = 3$ seem reasonable:

$$\begin{array}{r|rrrrr} 1 & 1 & -2 & 1 & -8 & -12 \\ & & 1 & -3 & 4 & -12 \\ \hline & 1 & -3 & 4 & -12 & 0 \\ -3 & 1 & -3 & 4 & -12 & \\ & & -3 & 0 & -12 & \\ \hline & 1 & 0 & 4 & 0 & \end{array}$$

$$x^4 - 2x^2 + x^2 - 8x + 12 = (x + 1)(x - 3)(x^2 + 4)$$

8. Possible real rational zeros: $\frac{\pm 1, \pm 2, \pm 5, \pm 10}{\pm 1}$ From a graph, $x = -1, x = -2$ and $x = 5$ seem reasonable:

$$\begin{array}{r|rrrrr} 1 & 1 & -1 & -15 & -23 & -10 \\ & & 1 & -2 & -13 & -10 \\ \hline & 1 & -2 & -13 & -10 & 0 \\ 2 & 1 & -2 & -13 & -10 & \\ & & 2 & -8 & -10 & \\ \hline & 1 & -4 & -5 & 0 & \\ -5 & 1 & -4 & -5 & & \\ & & -5 & -5 & & \\ \hline & 1 & 1 & 0 & & \end{array}$$

$$x^4 - x^3 - 15x^2 - 23x - 10 = (x + 1)^2(x + 2)(x - 5)$$

In #9-10, equate coefficients.

9. $A = 3, B = -1, C = 1$

10. $A = -2, B = 2, C = -1, D = -5$

Section 7.4 Exercises

1. $\frac{x^2 - 7}{x(x^2 - 4)} = \frac{A_1}{x} + \frac{A_2}{x - 2} + \frac{A_3}{x + 2}$

2. $\frac{x^4 + 3x^2 - 1}{(x^2 + x + 1)^2(x^2 - x + 1)} = \frac{B_1x + C_1}{x^2 + x + 1} + \frac{B_2x + C_2}{(x^2 + x + 1)^2} + \frac{B_3x + C_3}{x^2 - x + 1}$

3. $\frac{x^5 - 2x^4 + x - 1}{x^3(x - 1)^2(x^2 + 9)} = \frac{A_1}{x} + \frac{A_2}{x^2} + \frac{A_3}{x^3} + \frac{A_4}{x - 1} + \frac{A_5}{(x - 1)^2} + \frac{B_1x + C_1}{x^2 + 9}$

4. $\frac{x^2 + 3x + 2}{(x^3 - 1)^3} = \frac{x^2 + 3x + 2}{(x - 1)^3(x^2 + x + 1)^3} = \frac{A_1}{x - 1} + \frac{A_2}{(x - 1)^2} + \frac{A_3}{(x - 1)^3} + \frac{B_1x + C_1}{x^2 + x + 1} + \frac{B_2x + C_2}{(x^2 + x + 1)^2} + \frac{B_3x + C_3}{(x^2 + x + 1)^3}$

5. $\frac{-3}{x + 4} + \frac{4}{x - 2}; x + 22 = A(x - 2) + B(x + 4)$
 $= (A + B)x + (-2A + 4B)$
 $A + B = 1$
 $-2A + 4B = 22 \Rightarrow \begin{bmatrix} A \\ B \end{bmatrix} = \begin{bmatrix} 1 & 1 \\ -2 & 4 \end{bmatrix}^{-1} \begin{bmatrix} 1 \\ 22 \end{bmatrix} = \begin{bmatrix} -3 \\ 4 \end{bmatrix}$

6. $\frac{2}{x + 3} - \frac{1}{x}; x - 3 = Ax + B(x + 3)$
 $= (A + B)x + 3B$
 $A + B = 1$
 $0 + 3B = -3 \Rightarrow \begin{bmatrix} A \\ B \end{bmatrix} = \begin{bmatrix} 1 & 1 \\ 0 & 3 \end{bmatrix}^{-1} \begin{bmatrix} 1 \\ -3 \end{bmatrix} = \begin{bmatrix} 2 \\ -1 \end{bmatrix}$

7. $\frac{3}{x^2 + 1} + \frac{2x - 1}{(x^2 + 1)^2}; 3x^2 + 2x + 2 = (Ax + B)(x^2 + 1) + (Cx + D)$
 $= Ax^3 + Bx^2 + (A + C)x + (B + D)$
 $A = 0$
 $B = 3$
 $A + C = 2 \Rightarrow \begin{bmatrix} A \\ B \\ C \\ D \end{bmatrix} = \begin{bmatrix} 0 \\ 3 \\ 2 \\ 2 \end{bmatrix}$
 $B + D = 2$
 $= \begin{bmatrix} 1 & 0 & 0 & 0 \\ 0 & 1 & 0 & 0 \\ 1 & 0 & 1 & 0 \\ 0 & 1 & 0 & 1 \end{bmatrix}^{-1} \begin{bmatrix} 0 \\ 3 \\ 2 \\ 2 \end{bmatrix} = \begin{bmatrix} 0 \\ 3 \\ 2 \\ -1 \end{bmatrix}$

8. $\frac{1}{x} + \frac{2}{x^2} - \frac{1}{x + 2}; 4x + 4 = Ax(x + 2) + B(x + 2) + Cx^2$
 $= (A + C)x^2 + (2A + B)x + (2B)$
 $A + C = 0$
 $2A + B = 4$
 $2B = 4 \Rightarrow \begin{bmatrix} A \\ B \\ C \end{bmatrix} = \begin{bmatrix} 1 \\ 2 \\ -1 \end{bmatrix}$
 $= \begin{bmatrix} 1 & 0 & 1 \\ 2 & 1 & 0 \\ 0 & 2 & 0 \end{bmatrix}^{-1} \begin{bmatrix} 0 \\ 4 \\ 4 \end{bmatrix} = \begin{bmatrix} 1 \\ 2 \\ -1 \end{bmatrix}$

9. $\frac{1}{x - 2} + \frac{2}{(x - 2)^2} + \frac{1}{(x - 2)^3}; x^2 - 2x + 1 = A(x - 2)^2 + B(x - 2) + C$
 $= Ax^2 + (-4A + B)x + (4A - 2B + C)$
 $A = 1$
 $-4A + B = -2 \Rightarrow \begin{bmatrix} 1 & 0 & 0 & 1 \\ -4 & 1 & 0 & -2 \\ 4 & -2 & 1 & 1 \end{bmatrix}$
 $4A - 2B + C = 1$

Using a grapher, we find that the reduced row echelon form of the augmented matrix is:

$$\begin{bmatrix} 1 & 0 & 0 & 1 \\ 0 & 1 & 0 & 2 \\ 0 & 0 & 1 & 1 \end{bmatrix} \Rightarrow \begin{bmatrix} A \\ B \\ C \end{bmatrix} = \begin{bmatrix} 1 \\ 2 \\ 1 \end{bmatrix}$$

$$\begin{aligned}
 10. \quad & \frac{-3x + 7}{x^2 + 4} + \frac{8x - 17}{x^2 + 9} \\
 & 5x^3 - 10x^2 + 5x - 5 \\
 & = (Ax + B)(x^2 + 9) + (Cx + D)(x^2 + 4) \\
 & = (A + C)x^3 + (B + D)x^2 + (9A + 4C)x \\
 & \quad + (9B + 4D) \\
 & \begin{aligned} A + C &= 5 \\ B + D &= -10 \\ 9A + 4C &= 5 \\ 9B + 4D &= -5 \end{aligned} \Rightarrow
 \end{aligned}$$

$$\begin{bmatrix} 1 & 0 & 1 & 0 & 5 \\ 0 & 1 & 0 & 1 & -10 \\ 9 & 0 & 4 & 0 & 5 \\ 0 & 9 & 0 & 4 & -5 \end{bmatrix}$$

Using a grapher, we find that the reduced row echelon form of the augmented matrix is:

$$\begin{bmatrix} 1 & 0 & 0 & 0 & -3 \\ 0 & 1 & 0 & 0 & 7 \\ 0 & 0 & 1 & 0 & 8 \\ 0 & 0 & 0 & 1 & -17 \end{bmatrix} \Rightarrow \begin{bmatrix} A \\ B \\ C \\ D \end{bmatrix} = \begin{bmatrix} -3 \\ 7 \\ 8 \\ -17 \end{bmatrix}$$

$$\begin{aligned}
 11. \quad & \frac{2}{x + 3} - \frac{1}{(x + 3)^2} + \frac{3x - 1}{x^2 + 2} + \frac{x + 2}{(x^2 + 2)^2} \\
 & 5x^5 + 22x^4 + 36x^3 + 53x^2 + 71x + 20 \\
 & = A(x + 3)(x^2 + 2)^2 + B(x^2 + 2)^2 \\
 & \quad + (Cx + D)(x + 3)^2(x^2 + 2) + (Ex + F)(x + 3)^2 \\
 & = (A + C)x^5 + (3A + B + 6C + D)x^4 \\
 & \quad + (4A + 11C + 6D + E)x^3 + (12A + 4B + 12C \\
 & \quad + 11D + 6E + F)x^2 + (4A + 18C + 12D + 9E \\
 & \quad + 6F)x + (12A + 4B + 18D + 9F) \\
 & \begin{aligned} A + C &= 5 \\ 3A + B + 6C + D &= 22 \\ 4A + 11C + 6D + E &= 36 \\ 12A + 4B + 12C + 11D + 6E + F &= 53 \\ 4A + 18C + 12D + 9E + 6F &= 71 \\ 12A + 4B + 18D + 9F &= 20 \end{aligned} \Rightarrow
 \end{aligned}$$

$$\begin{bmatrix} 1 & 0 & 1 & 0 & 0 & 0 & 5 \\ 3 & 1 & 6 & 1 & 0 & 0 & 22 \\ 4 & 0 & 11 & 6 & 1 & 0 & 36 \\ 12 & 4 & 12 & 11 & 6 & 1 & 53 \\ 4 & 0 & 18 & 12 & 9 & 6 & 71 \\ 12 & 4 & 0 & 18 & 0 & 9 & 20 \end{bmatrix}$$

Using a grapher, we find that the reduced row echelon form of the augmented matrix is:

$$\begin{bmatrix} 1 & 0 & 0 & 0 & 0 & 0 & 2 \\ 0 & 1 & 0 & 0 & 0 & 0 & -1 \\ 0 & 0 & 1 & 0 & 0 & 0 & 3 \\ 0 & 0 & 0 & 1 & 0 & 0 & -1 \\ 0 & 0 & 0 & 0 & 1 & 0 & 1 \\ 0 & 0 & 0 & 0 & 0 & 1 & 2 \end{bmatrix} \Rightarrow \begin{bmatrix} A \\ B \\ C \\ D \\ E \\ F \end{bmatrix} = \begin{bmatrix} 2 \\ -1 \\ 3 \\ -1 \\ 1 \\ 2 \end{bmatrix}$$

$$\begin{aligned}
 12. \quad & \frac{-2}{x - 1} + \frac{3}{(x - 1)^2} + \frac{1}{x + 4} + \frac{3}{(x + 4)^2} \\
 & -x^3 - 6x^2 - 5x + 87 = A(x - 1)(x + 4)^2 \\
 & \quad + B(x + 4)^2 + C(x - 1)^2(x + 4) + D(x - 1)^2 \\
 & = (A + C)x^3 + (7A + B + 2C + D)x^2 \\
 & \quad + (8A + 8B - 7C - 2D)x \\
 & \quad + (-16A + 16B + 4C + D)
 \end{aligned}$$

$$\begin{aligned}
 & \begin{aligned} A + C &= -1 \\ 7A + B + 2C + D &= -6 \\ 8A + 8B - 7C - 2D &= -5 \\ -16A + 16B + 4C + D &= 87 \end{aligned} \Rightarrow \\
 & \begin{bmatrix} 1 & 0 & 1 & 0 & -1 \\ 7 & 1 & 2 & 1 & -6 \\ 8 & 8 & -7 & -2 & -5 \\ -16 & 16 & 4 & 1 & 87 \end{bmatrix}
 \end{aligned}$$

Using a grapher, we find that the reduced row echelon form of the augmented matrix is:

$$\begin{bmatrix} 1 & 0 & 0 & 0 & -2 \\ 0 & 1 & 0 & 0 & 3 \\ 0 & 0 & 1 & 0 & 1 \\ 0 & 0 & 0 & 1 & 3 \end{bmatrix} \Rightarrow \begin{bmatrix} A \\ B \\ C \\ D \end{bmatrix} = \begin{bmatrix} -2 \\ 3 \\ 1 \\ 3 \end{bmatrix}$$

$$\begin{aligned}
 13. \quad & \frac{2}{(x - 5)(x - 3)} = \frac{A_1}{x - 5} + \frac{A_2}{x - 3}, \text{ so} \\
 & 2 = A_1(x - 3) + A_2(x - 5). \text{ With } x = 5, \text{ we see that} \\
 & 2 = 2A_1, \text{ so } A_1 = 1; \text{ with } x = 3 \text{ we have } 2 = -2A_2, \text{ so} \\
 & A_2 = -1: \frac{1}{x - 5} - \frac{1}{x - 3}.
 \end{aligned}$$

$$\begin{aligned}
 14. \quad & \frac{4}{(x + 3)(x + 7)} = \frac{A_1}{x + 3} + \frac{A_2}{x + 7}, \text{ so} \\
 & 4 = A_1(x + 7) + A_2(x + 3). \text{ With } x = -3, \text{ we see that} \\
 & 4 = 4A_1, \text{ so } A_1 = 1; \text{ with } x = -7 \text{ we have } 4 = -4A_2, \\
 & \text{so } A_2 = -1: \frac{1}{x + 3} - \frac{1}{x + 7}.
 \end{aligned}$$

$$\begin{aligned}
 15. \quad & \frac{4}{x^2 - 1} = \frac{A_1}{x - 1} + \frac{A_2}{x + 1}, \text{ so} \\
 & 4 = A_1(x + 1) + A_2(x - 1). \text{ With } x = 1, \text{ we see that} \\
 & 4 = 2A_1, \text{ so } A_1 = 2; \text{ with } x = -1 \text{ we have } 4 = -2A_2, \text{ so} \\
 & A_2 = -2: \frac{2}{x - 1} - \frac{2}{x + 1}.
 \end{aligned}$$

$$\begin{aligned}
 16. \quad & \frac{6}{x^2 - 9} = \frac{A_1}{x - 3} + \frac{A_2}{x + 3}, \text{ so} \\
 & 6 = A_1(x + 3) + A_2(x - 3). \text{ With } x = 3, \text{ we see that} \\
 & 6 = 6A_1, \text{ so } A_1 = 1; \text{ with } x = -3 \text{ we have } 6 = -6A_2, \text{ so} \\
 & A_2 = -1: \frac{1}{x - 3} - \frac{1}{x + 3}.
 \end{aligned}$$

$$\begin{aligned}
 17. \quad & \frac{1}{x^2 + 2x} = \frac{A_1}{x} + \frac{A_2}{x + 2}, \text{ so } 1 = A_1(x + 2) + A_2x. \\
 & \text{With } x = 0, \text{ we see that } 1 = 2A_1, \text{ so } A_1 = \frac{1}{2}; \text{ with}
 \end{aligned}$$

$$x = -2, \text{ we have } 1 = -2A_2, \text{ so } A_2 = -\frac{1}{2}.$$

$$\frac{1/2}{x} - \frac{1/2}{x + 2} = \frac{1}{2x} - \frac{1/2}{x + 2}.$$

$$\begin{aligned}
 18. \quad & \frac{-6}{x^2 - 3x} = \frac{A_1}{x} + \frac{A_2}{x - 3}, \text{ so} \\
 & -6 = A_1(x - 3) + A_2x. \text{ With } x = 0, \text{ we see that} \\
 & -6 = -3A_1, \text{ so } A_1 = 2; \text{ with } x = 3 \text{ we have } -6 = 3A_2, \\
 & \text{so} \\
 & A_2 = -2: \frac{-2}{x - 3} + \frac{2}{x}.
 \end{aligned}$$

19. $\frac{-x+10}{x^2+x-12} = \frac{A_1}{x-3} + \frac{A_2}{x+4}$, so $-x+10 = A_1(x+4) + A_2(x-3)$. With $x=3$, we see that $7=7A_1$, so $A_1=1$; with $x=-4$ we have $14=-7A_2$, so $A_2=-2$: $\frac{1}{x-3} - \frac{2}{x+4}$.
20. $\frac{7x-7}{x^2-3x-10} = \frac{A_1}{x-5} + \frac{A_2}{x+2}$, so $7x-7 = A_1(x+2) + A_2(x-5)$. With $x=5$, we see that $28=7A_1$, so $A_1=4$; with $x=-2$ we have $-21=-7A_2$, so $A_2=3$: $\frac{4}{x-5} + \frac{3}{x+2}$.
21. $\frac{x+17}{2x^2+5x-3} = \frac{A_1}{x+3} + \frac{A_2}{2x-1}$, so $x+17 = A_1(2x-1) + A_2(x+3)$. With $x=-3$, we see that $14=-7A_1$, so $A_1=-2$; with $x=\frac{1}{2}$ we have $\frac{35}{2} = \frac{7}{2}A_2$, so $A_2=5$: $\frac{-2}{x+3} + \frac{5}{2x-1}$.
22. $\frac{4x-11}{2x^2-x-3} = \frac{A_1}{x+1} + \frac{A_2}{2x-3}$, so $4x-11 = A_1(2x-3) + A_2(x+1)$. With $x=-1$, we see that $-15=-5A_1$, so $A_1=3$; with $x=\frac{3}{2}$ we have $-5 = \frac{5}{2}A_2$, so $A_2=-2$: $\frac{3}{x+1} - \frac{2}{2x-3}$.
23. $\frac{2x^2+5}{(x^2+1)^2} = \frac{B_1x+C_1}{x^2+1} + \frac{B_2x+C_2}{(x^2+1)^2}$, so $2x^2+5 = (B_1x+C_1)(x^2+1) + B_2x+C_2$. Expanding the right side leaves $2x^2+5 = B_1x^3 + C_1x^2 + (B_1+B_2)x + C_1+C_2$; equating coefficients reveals that $B_1=0, C_1=2, B_1+B_2=0$, and $C_1+C_2=5$. This means that $B_2=0$ and $C_2=3$: $\frac{2}{x^2+1} + \frac{3}{(x^2+1)^2}$.
24. $\frac{3x^2+4}{(x^2+1)^2} = \frac{B_1x+C_1}{x^2+1} + \frac{B_2x+C_2}{(x^2+1)^2}$, so $3x^2+4 = (B_1x+C_1)(x^2+1) + B_2x+C_2$. Expanding the right side leaves $3x^2+4 = B_1x^3 + C_1x^2 + (B_1+B_2)x + C_1+C_2$; equating coefficients reveals that $B_1=0, C_1=3, B_1+B_2=0$, and $C_1+C_2=4$. This means that $B_2=0$ and $C_2=1$: $\frac{3}{x^2+1} + \frac{1}{(x^2+1)^2}$.
25. The denominator factors into $x(x-1)^2$, so $\frac{x^2-x+2}{x^3-2x^2+x} = \frac{A_1}{x} + \frac{A_2}{x-1} + \frac{A_3}{(x-1)^2}$. Then $x^2-x+2 = A_1(x-1)^2 + A_2x(x-1) + A_3x$. With $x=0$, we have $2=A_1$; with $x=1$, we have $2=A_3$; with $x=2$, we have $4=A_1+2A_2+2A_3=2+2A_2+4$, so $A_2=-1$: $\frac{2}{x} - \frac{1}{x-1} + \frac{2}{(x-1)^2}$.
26. The denominator factors into $x(x-3)^2$, so $\frac{-6x+25}{x^3-6x^2+9x} = \frac{A_1}{x} + \frac{A_2}{x-3} + \frac{A_3}{(x-3)^2}$. Then $-6x+25 = A_1(x-3)^2 + A_2x(x-3) + A_3x$. With

- $x=0$, we have $25=9A_1$; so $A_1=\frac{25}{9}$; with $x=3$, we have $7=3A_3$; so $A_3=\frac{7}{3}$; with $x=4$, we have $1=A_1+4A_2+4A_3=\frac{25}{9}+4A_2+\frac{28}{3}$, so $A_2=-\frac{25}{9}$: $\frac{7/3}{(x-3)^2} - \frac{25/9}{x-3} + \frac{25/9}{x}$.
27. $\frac{3x^2-4x+3}{x^3-3x^2} = \frac{A_1}{x} + \frac{A_2}{x^2} + \frac{A_3}{x-3}$. Then $3x^2-4x+3 = A_1x(x-3) + A_2(x-3) + A_3x^2$. With $x=0$, we have $3=-3A_2$, so $A_2=-1$; with $x=3$, we have $18=9A_3$, so $A_3=2$; with $x=1$, we have $2=-2A_1-2A_2+A_3=-2A_1+2+2$, so $A_1=1$: $\frac{1}{x} - \frac{1}{x^2} + \frac{2}{x-3}$.
28. $\frac{5x^2+7x-4}{x^3+4x^2} = \frac{A_1}{x} + \frac{A_2}{x^2} + \frac{A_3}{x+4}$. Then $5x^2+7x-4 = A_1x(x+4) + A_2(x+4) + A_3x^2$. With $x=0$, we have $-4=4A_2$, so $A_2=-1$; with $x=-4$, we have $48=16A_3$, so $A_3=3$; with $x=1$, we have $8=5A_1+5A_2+A_3=5A_1-5+3$, so $A_1=2$: $\frac{2}{x} - \frac{1}{x^2} + \frac{3}{x+4}$.
29. $\frac{2x^3+4x-1}{(x^2+2)^2} = \frac{B_1x+C_1}{x^2+2} + \frac{B_2x+C_2}{(x^2+2)^2}$. Then $2x^3+4x-1 = (B_1x+C_1)(x^2+2) + B_2x+C_2$. Expanding the right side and equating coefficients reveals that $B_1=2, C_1=0, 2B_1+B_2=4$, and $2C_1+C_2=-1$. This means that $B_2=0$ and $C_2=-1$: $\frac{2x}{x^2+2} - \frac{1}{(x^2+2)^2}$.
30. $\frac{3x^3+6x-1}{(x^2+2)^2} = \frac{B_1x+C_1}{x^2+2} + \frac{B_2x+C_2}{(x^2+2)^2}$. Then $3x^3+6x-1 = (B_1x+C_1)(x^2+2) + B_2x+C_2$. Expanding the right side and equating coefficients reveals that $B_1=3, C_1=0, 2B_1+B_2=6$, and $2C_1+C_2=-1$. This means that $B_2=0$ and $C_2=-1$: $\frac{3x}{x^2+2} - \frac{1}{(x^2+2)^2}$.
31. The denominator factors into $(x-1)(x^2+x+1)$, so $\frac{x^2+3x+2}{x^3-1} = \frac{A}{x-1} + \frac{Bx+C}{x^2+x+1}$. Then $x^2+3x+2 = A(x^2+x+1) + (Bx+C)(x-1)$. With $x=1$, we have $6=3A$, so $A=2$; with $x=0$, $2=A-C$, so $C=0$. Finally, with $x=2$, we have $12=7A+2B$, so $B=-1$: $\frac{2}{x-1} - \frac{x}{x^2+x+1}$.
32. The denominator factors into $(x+1)(x^2-x+1)$, so $\frac{2x^2-4x+3}{x^3+1} = \frac{A}{x+1} + \frac{Bx+C}{x^2-x+1}$. Then $2x^2-4x+3 = A(x^2-x+1) + (Bx+C)(x+1)$. With $x=-1$, we have $9=3A$, so $A=3$; with $x=0$, $3=A+C$, so $C=0$. Finally, with $x=-2$, we have $19=7A+2B$, so $B=-1$: $\frac{3}{x+1} - \frac{x}{x^2-x+1}$.

In #33–36, find the quotient and remainder via long division or other methods (note in particular that if the degree of the numerator and denominator are the same, the quotient is the ratio of the leading coefficients). Use the usual methods to find the partial fraction decomposition.

$$33. \frac{2x^2 + x + 3}{x^2 - 1} = 2 + \frac{x + 5}{x^2 - 1}; \frac{r(x)}{h(x)} = \frac{x + 5}{x^2 - 1}$$

$$= \frac{A_1}{x - 1} + \frac{A_2}{x + 1}, \text{ so } x + 5 = A_1(x + 1) + A_2(x - 1). \text{ With } x = 1 \text{ and } x = -1 \text{ (respectively),}$$

$$\text{we find that } A_1 = 3 \text{ and } A_2 = -2: \frac{3}{x - 1} - \frac{2}{x + 1}.$$

Graph of $\frac{2x^2 + x + 3}{x^2 - 1}$:

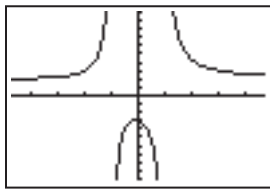

[-4.7, 4.7] by [-10, 10]

Graph of $y = 2$:

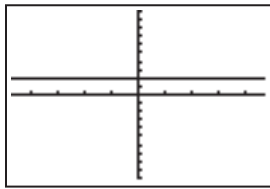

[-4.7, 4.7] by [-10, 10]

Graph of $\frac{3}{x - 1}$:

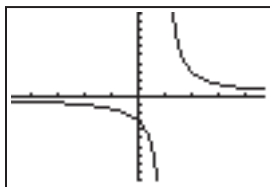

[-4.7, 4.7] by [-10, 10]

Graph of $-\frac{2}{x + 1}$:

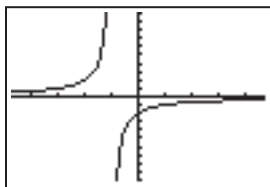

[-4.7, 4.7] by [-10, 10]

$$34. \frac{3x^2 + 2x}{x^2 - 4} = 3 + \frac{2x + 12}{x^2 - 4}; \frac{r(x)}{h(x)} = \frac{2x + 12}{x^2 - 4}$$

$$= \frac{A_1}{x - 2} + \frac{A_2}{x + 2}, \text{ so } 2x + 12 = A_1(x + 2) + A_2(x - 2). \text{ With } x = 2 \text{ and } x = -2 \text{ (respectively),}$$

$$\text{we find that } A_1 = 4 \text{ and } A_2 = -2: \frac{4}{x - 2} - \frac{2}{x + 2}.$$

Graph of $\frac{3x^2 + 2x}{x^2 - 4}$:

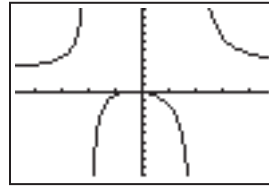

[-4.7, 4.7] by [-10, 10]

Graph of $y = 3$:

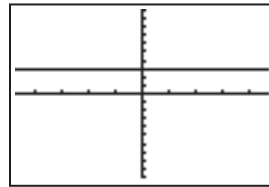

[-4.7, 4.7] by [-10, 10]

Graph of $\frac{4}{x - 2}$:

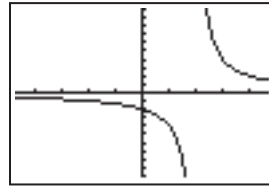

[-4.7, 4.7] by [-10, 10]

Graph of $-\frac{2}{x + 2}$:

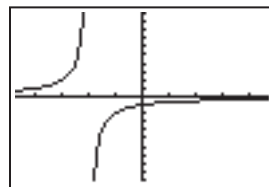

[-4.7, 4.7] by [-10, 10]

$$35. \frac{x^3 - 2}{x^2 + x} = x - 1 + \frac{x - 2}{x^2 + x}; \frac{r(x)}{h(x)} = \frac{x - 2}{x^2 + x}$$

$$= \frac{A_1}{x + 1} + \frac{A_2}{x}, \text{ so } x - 2 = A_1x + A_2(x + 1). \text{ With } x = -1 \text{ and } x = 0 \text{ (respectively), we find that } A_1 = 3$$

$$\text{and } A_2 = -2: \frac{3}{x + 1} - \frac{2}{x}.$$

Graph of $y = \frac{x^3 - 2}{x^2 + x}$:

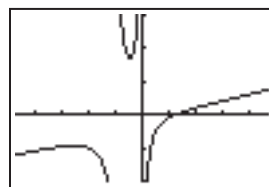

[-4.7, 4.7] by [-10, 15]

Graph of $y = x - 1$:

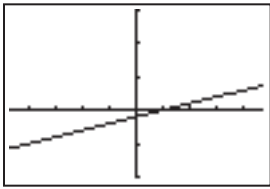

$[-4.7, 4.7]$ by $[-10, 15]$

Graph of $y = \frac{3}{x + 1}$:

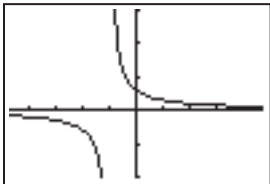

$[-4.7, 4.7]$ by $[-10, 15]$

Graph of $y = -\frac{2}{x}$:

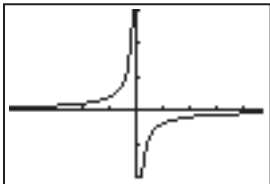

$[-4.7, 4.7]$ by $[-10, 15]$

36. $\frac{x^3 + 2}{x^2 - x} = x + 1 + \frac{x + 2}{x^2 - x}$; $r(x) = \frac{x + 2}{x^2 - x}$
 $= \frac{A_1}{x - 1} + \frac{A_2}{x}$, so $x + 2 = A_1x + A_2(x - 1)$. With $x = 1$ and $x = 0$ (respectively), we find that $A_1 = 3$ and $A_2 = -2$: $\frac{3}{x - 1} - \frac{2}{x}$ (note the similarity to #35).

Graph of $y = \frac{x^3 + 2}{x^2 - x}$:

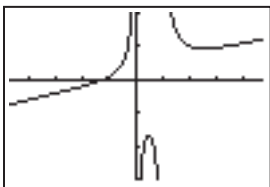

$[-4.7, 4.7]$ by $[-15, 10]$

Graph of $y = x + 1$:

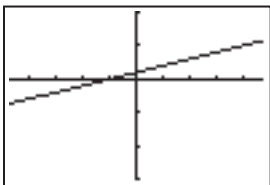

$[-4.7, 4.7]$ by $[-15, 10]$

Graph of $y = \frac{3}{x - 1}$:

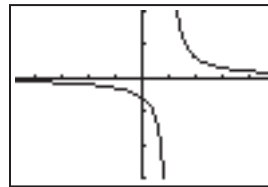

$[-4.7, 4.7]$ by $[-15, 10]$

Graph of $y = \frac{2}{x}$:

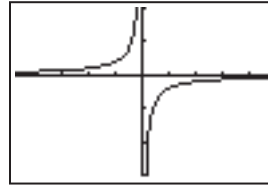

$[-4.7, 4.7]$ by $[-15, 10]$

37. (c)

38. (f)

39. (d)

40. (b)

41. (a)

42. (e)

43. $\frac{-1}{ax} + \frac{1}{a(x - a)}$:

$$1 = A(x - a) + Bx = (A + B)x - aA$$

$$A + B = 0$$

$$-aA = 1$$

$$\text{Since } A = -\frac{1}{a}, -\frac{1}{a} + B = 0, B = \frac{1}{a}$$

$$\begin{bmatrix} A \\ B \end{bmatrix} = \begin{bmatrix} -\frac{1}{a} \\ \frac{1}{a} \end{bmatrix}$$

44. $\frac{1}{(b - 2)(x - 2)} - \frac{1}{(b - 2)(x - b)}$:

$$-1 = A(x - b) + B(x - 2) = (A + B)x + (-bA - 2B)$$

$$A + B = 0 \Rightarrow \begin{bmatrix} 1 & 1 & 0 \\ -b & -2 & -1 \end{bmatrix}$$

$$-bA - 2B = -1$$

$$\begin{bmatrix} 1 & 1 & 0 \\ 0 & b - 2 & -1 \end{bmatrix} \Rightarrow \begin{bmatrix} 1 & 1 & 0 \\ 0 & 1 & \frac{-1}{b - 2} \end{bmatrix} \Rightarrow$$

$$\begin{bmatrix} 1 & 0 & \frac{1}{b - 2} \\ 0 & 1 & \frac{-1}{b - 2} \end{bmatrix} \Rightarrow \begin{bmatrix} A \\ B \end{bmatrix} = \begin{bmatrix} \frac{1}{b - 2} \\ \frac{-1}{b - 2} \end{bmatrix}$$

$$45. \frac{-3}{(b-a)(x-a)} + \frac{3}{(b-a)(x-b)};$$

$$3 = A(x-b) + B(x-a) = (A+B)x + (-bA - aB)$$

$$\begin{aligned} A + B &= 0 \\ -bA - aB &= 3 \end{aligned} \Rightarrow \begin{bmatrix} 1 & 1 & 0 \\ -b & -a & 3 \end{bmatrix} \Rightarrow$$

$$\begin{bmatrix} 1 & 1 & 0 \\ 0 & b-a & 3 \end{bmatrix} \Rightarrow \begin{bmatrix} 1 & 1 & 0 \\ 0 & 1 & \frac{3}{b-a} \end{bmatrix} \Rightarrow$$

$$\begin{bmatrix} 1 & 0 & \frac{-3}{b-a} \\ 0 & 1 & \frac{3}{b-a} \end{bmatrix} \Rightarrow \begin{bmatrix} A \\ B \end{bmatrix} = \begin{bmatrix} \frac{-3}{b-a} \\ \frac{3}{b-a} \end{bmatrix}$$

$$46. \frac{-1}{a(x+a)} + \frac{1}{a(x-a)};$$

$$2 = A(x-a) + B(x+a) = (A+B)x + (-aA + aB)$$

$$\begin{aligned} A + B &= 0 \\ -aA + aB &= 2 \end{aligned} \Rightarrow \begin{bmatrix} 1 & 1 & 0 \\ -a & a & 2 \end{bmatrix} \Rightarrow$$

$$\begin{bmatrix} 1 & 1 & 0 \\ 0 & 2a & 2 \end{bmatrix} \Rightarrow \begin{bmatrix} 1 & 1 & 0 \\ 0 & 1 & \frac{1}{a} \end{bmatrix} \Rightarrow$$

$$\begin{bmatrix} 1 & 0 & -\frac{1}{a} \\ 0 & 1 & \frac{1}{a} \end{bmatrix} \Rightarrow \begin{bmatrix} A \\ B \end{bmatrix} = \begin{bmatrix} -\frac{1}{a} \\ \frac{1}{a} \end{bmatrix}$$

47. True. The behavior of $f(x)$ near $x = 3$ is the same as the behavior of $y = \frac{1}{x-3}$, and $\lim_{x \rightarrow 3^+} \frac{1}{x-3} = -\infty$.

48. True. The behavior of $f(x)$ for $|x|$ large is the same as the behavior of $y = -1$, and $\lim_{x \rightarrow \infty} (-1) = -1$.

49. The denominator factor x^2 calls for the terms $\frac{A_1}{x}$ and $\frac{A_2}{x^2}$ in the partial fraction decomposition, and the denominator factor $x^2 + 2$ calls for the term $\frac{B_1x + C_1}{x^2 + 2}$.

The answer is E.

50. The denominator factor $(x+3)^2$ calls for terms $\frac{A_1}{x+3}$ and $\frac{A_2}{(x+3)^2}$ in the partial fraction decomposition, and the denominator factor $(x^2+4)^2$ calls for the terms $\frac{B_1x + C_1}{x^2+4}$ and $\frac{B_2x + C_2}{(x^2+4)^2}$. The answer is C.

51. The y -intercept is -1 , and because the denominators are both of degree 1, the expression changes sign at each asymptote. The answer is B.

52. The y -intercept is $\frac{3}{4}$, and the expression changes sign at the $x = 1$ asymptote but is negative on both sides of the $x = -2$ asymptote. The answer is E.

53. (a) $x = 1: 1 + 4 + 1 = A(1+1) + (B+C)(0)$
 $6 = 2A$
 $A = 3$

(b) $x = i: -1 + 4i + 1 = 3(-1+1) + (Bi+C)(i-1)$
 $4i = (Bi+C)(i-1)$
 $4i = -B - Bi + Ci - C$
 $-B - C = 0 \Rightarrow B + C = 0$
 $-Bi + Ci = 4i \Rightarrow B - C = -4 \Rightarrow$
 $\begin{bmatrix} 1 & 1 & 0 \\ 1 & -1 & -4 \end{bmatrix} \Rightarrow \begin{bmatrix} 1 & 1 & 0 \\ 0 & -2 & -4 \end{bmatrix} \Rightarrow \begin{bmatrix} 1 & 1 & 0 \\ 0 & 1 & 2 \end{bmatrix} \Rightarrow$
 $\begin{bmatrix} 1 & 0 & -2 \\ 0 & 1 & 2 \end{bmatrix} \Rightarrow \begin{bmatrix} B \\ C \end{bmatrix} = \begin{bmatrix} -2 \\ 2 \end{bmatrix}$
 $x = -i$
 $-1 - 4i + 1 = A(-1-1) + (-Bi+C)(-i-1)$
 $-4i = -B + Bi - Ci - C$, which is the same as above.
 $B = -2, C = 2$

54. One possible answer: For any two polynomials to be equal over the entire range of real or complex numbers, the coefficients of each power must be equal. (For example $2x^3 = 2x^2$ only when $x = 0$ and $x = 1$: at all other values of x , the functions are *not* equal).

55. $y = \frac{b}{(x-1)^2}$ has a greater effect on $f(x)$ at $x = 1$.

56. Using partial fractions, $f(x) = \frac{2}{x-1} + \frac{-1}{(x-1)^2}$ while

$$g(x) = \frac{2}{x-1} + \frac{5}{(x-1)^2}.$$

Near $x = 1$, the term

$\frac{-1}{(x-1)^2}$ dominates $f(x)$; at the same value of x , the term

$\frac{5}{(x-1)^2}$ dominates $g(x)$. Near $x = 1$, then, we expect $f(x)$ to approach $-\infty$ and $g(x)$ to approach $+\infty$.

Section 7.5 Systems of Inequalities in Two Variables

Quick Review 7.5

1. x -intercept: $(3, 0)$; y -intercept: $(0, -2)$

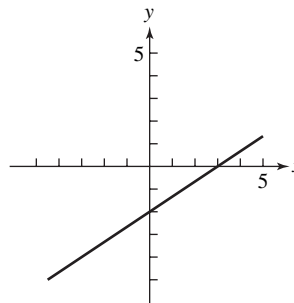

2. x -intercept: $(6, 0)$; y -intercept: $(0, 3)$

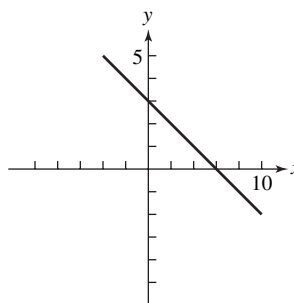

3. x-intercept: (20, 0); y-intercept: (0, 50)

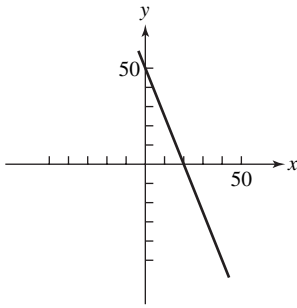

4. x-intercept: (30, 0); y-intercept: (0, -20)

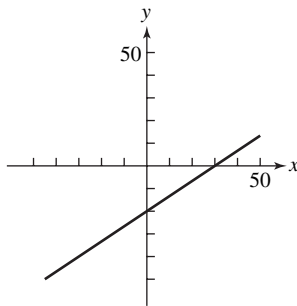

For #5–9, a variety of methods could be used. One is shown.

$$5. \begin{bmatrix} 4 & 1 & 180 \\ 1 & 1 & 90 \end{bmatrix} \Rightarrow \begin{bmatrix} 1 & \frac{1}{4} & 45 \\ 0 & 1 & 60 \end{bmatrix} \Rightarrow \begin{bmatrix} 1 & 0 & 30 \\ 0 & 1 & 60 \end{bmatrix} \Rightarrow \begin{bmatrix} x \\ y \end{bmatrix} = \begin{bmatrix} 30 \\ 60 \end{bmatrix}$$

$$6. \begin{bmatrix} 1 & 1 & 90 \\ 10 & 5 & 800 \end{bmatrix} \Rightarrow \begin{bmatrix} 1 & 1 & 90 \\ 0 & 1 & 20 \end{bmatrix} \Rightarrow \begin{bmatrix} 1 & 0 & 70 \\ 0 & 1 & 20 \end{bmatrix} \Rightarrow \begin{bmatrix} x \\ y \end{bmatrix} = \begin{bmatrix} 70 \\ 20 \end{bmatrix}$$

$$7. \begin{bmatrix} 4 & 1 & 180 \\ 10 & 5 & 800 \end{bmatrix} \Rightarrow \begin{bmatrix} 1 & \frac{1}{4} & 45 \\ 0 & 1 & 140 \end{bmatrix} \Rightarrow \begin{bmatrix} 1 & 0 & 10 \\ 0 & 1 & 140 \end{bmatrix} \Rightarrow \begin{bmatrix} x \\ y \end{bmatrix} = \begin{bmatrix} 10 \\ 140 \end{bmatrix}$$

$$8. \begin{bmatrix} 1 & 1 & 6 \\ 8 & 2 & 24 \end{bmatrix} \Rightarrow \begin{bmatrix} 1 & 1 & 6 \\ 0 & 1 & 4 \end{bmatrix} \Rightarrow \begin{bmatrix} 1 & 0 & 2 \\ 0 & 1 & 4 \end{bmatrix} \Rightarrow \begin{bmatrix} x \\ y \end{bmatrix} = \begin{bmatrix} 2 \\ 4 \end{bmatrix}$$

$$9. \begin{bmatrix} 1 & 1 & 6 \\ 2 & 8 & 30 \end{bmatrix} \Rightarrow \begin{bmatrix} 1 & 1 & 6 \\ 0 & 1 & 3 \end{bmatrix} \Rightarrow \begin{bmatrix} 1 & 0 & 3 \\ 0 & 1 & 3 \end{bmatrix} \Rightarrow \begin{bmatrix} x \\ y \end{bmatrix} = \begin{bmatrix} 3 \\ 3 \end{bmatrix}$$

10. Use substitution: $2x + 3x^2 = 4$, $3x^2 + 2x - 4 = 0$,

$$x = \frac{-2 \pm \sqrt{4 - 4(3)(-4)}}{6},$$

$$(x, y) \approx (-1.54, 2.36) \text{ or } (0.87, 0.75)$$

Section 7.5 Exercises

1. Graph (c); boundary included
2. Graph (f); boundary excluded
3. Graph (b); boundary included
4. Graph (d); boundary excluded
5. Graph (e); boundary included
6. Graph (a); boundary excluded

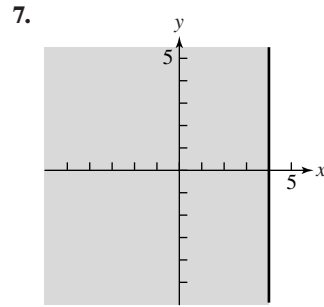

boundary line $x = 4$ included

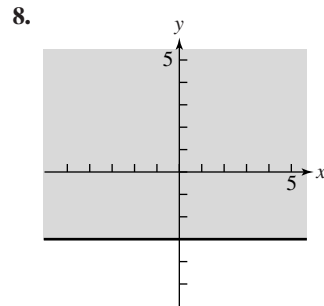

boundary line $y = -3$ included

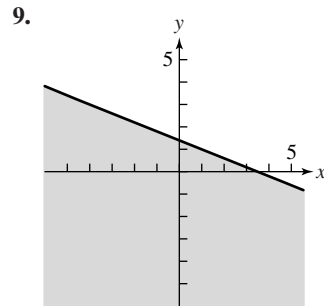

boundary line $2x + 5y = 7$ included

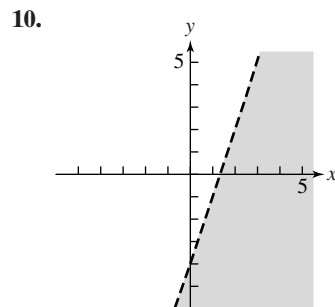

boundary line $3x - y = 4$ excluded

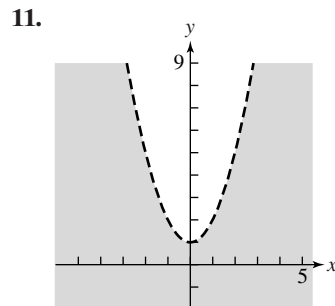

boundary curve $y = x^2 + 1$ excluded

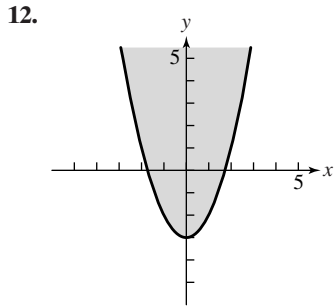

boundary curve $y = x^2 - 3$ included

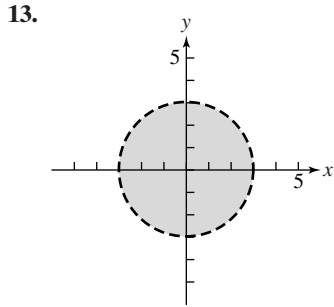

boundary circle $x^2 + y^2 = 9$ excluded

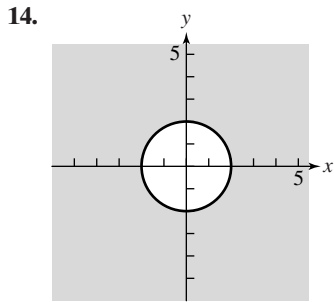

boundary circle $x^2 + y^2 = 4$ included

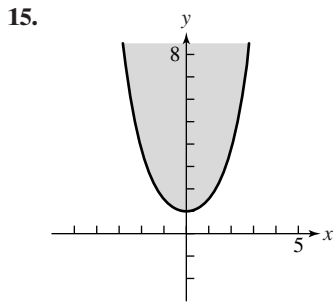

boundary curve $y = \frac{e^x + e^{-x}}{2}$ included

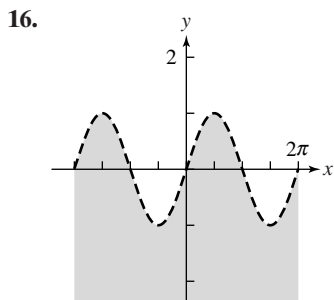

boundary curve $y = \sin x$ excluded

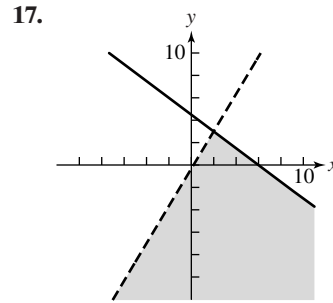

Corner at $(2, 3)$. Left boundary is excluded, the other is included.

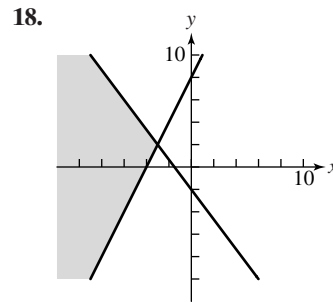

Corner at $(-3, 2)$. Boundaries included.

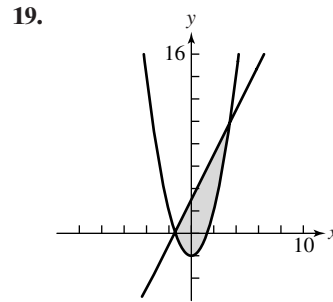

Corners at about $(-1.45, 0.10)$ and $(3.45, 9.90)$. Boundaries included.

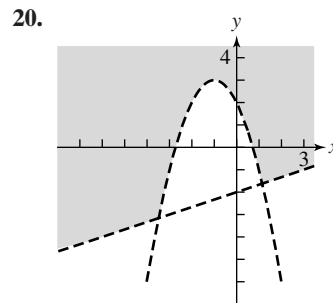

Corners at about $(-3.48, -3.16)$ and $(1.15, -1.62)$. Boundaries excluded.

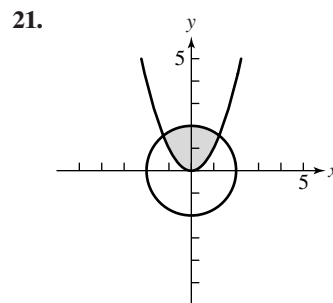

Corners at about $(\pm 1.25, 1.56)$ Boundaries included.

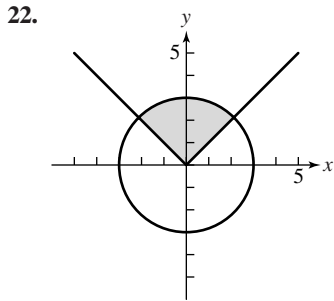

Corners at about $(\pm 2.12, 2.12)$

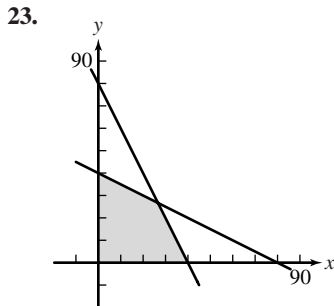

Corners at $(0, 40)$, $(26.7, 26.7)$, $(0, 0)$, and $(40, 0)$.
Boundaries included.

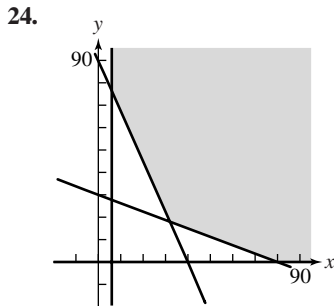

Corners at $(6, 76.5)$, $(32, 18)$, and $(80, 0)$. Boundaries included.

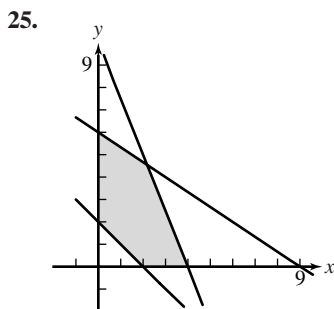

Corners at $(0, 2)$, $(0, 6)$, $(2.18, 4.55)$, $(4, 0)$, and $(2, 0)$.
Boundaries included.

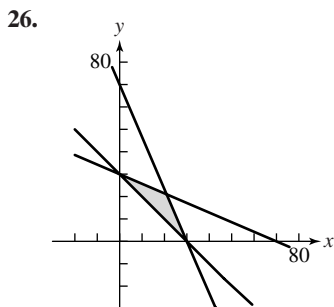

Corners at $(0, 30)$, $(21, 21)$, and $(30, 0)$. Boundaries included.

27. $x^2 + y^2 \leq 4$
 $y \geq -x^2 + 1$

28. $x^2 + y^2 \leq 4$
 $y \geq 0$

For #29–30, first we must find the equations of the lines—then the inequalities.

29. line 1: $m = \frac{\Delta y}{\Delta x} = \frac{(5 - 3)}{(0 - 4)} = \frac{2}{-4} = \frac{-1}{2}, y = \frac{-1}{2}x + 5$

line 2: $m = \frac{\Delta y}{\Delta x} = \frac{(0 - 3)}{(6 - 4)} = \frac{-3}{2},$

$(y - 0) = \frac{-3}{2}(x - 6), y = \frac{-3}{2}x + 9$

line 3: $x = 0$

line 4: $y = 0$

$y \leq \frac{-1}{2}x + 5$

$y \leq \frac{-3}{2}x + 9$

$x \geq 0$

$y \geq 0$

30. line 1: $\frac{\Delta y}{\Delta x} = \frac{(1 - 6)}{(2 - 0)} = \frac{-5}{2}, y = \frac{-5}{2}x + 6$

line 2: $\frac{\Delta y}{\Delta x} = \frac{(1 - 0)}{(2 - 5)} = \frac{1}{-3} = \frac{-1}{3},$

$(y - 0) = \frac{-1}{3}(x - 5), y = \frac{-1}{3}x + \frac{5}{3}$

line 3: $x = 0$

line 4: $y = 0$

$y \geq \frac{-5}{2}x + 6$

$y \geq \frac{-1}{3}x + \frac{5}{3}$

$x \geq 0$

$y \geq 0$

For #31–36, the feasible area, use your grapher to determine the feasible area, and then solve for the corner points graphically or algebraically. Evaluate $f(x)$ at the corner points to determine maximum and minimum values.

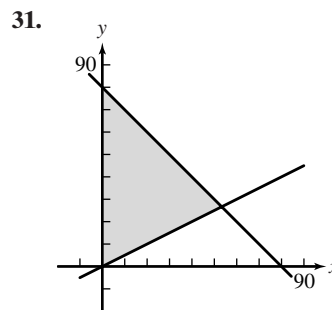

Corner points: $(0, 0)$

$(0, 80)$, the y-intercept of $x + y = 80$

$(\frac{160}{3}, \frac{80}{3})$, the intersection of $x + y = 80$

and $x - 2y = 0$

(x, y)	$(0, 0)$	$(0, 80)$	$(\frac{160}{3}, \frac{80}{3})$
----------	----------	-----------	---------------------------------

f	0	240	$\frac{880}{3} \approx 293.33$
-----	---	-----	--------------------------------

$f_{\min} = 0$ [at $(0, 0)$]; $f_{\max} \approx 293.33$ [at $(\frac{160}{3}, \frac{80}{3})$]

32.

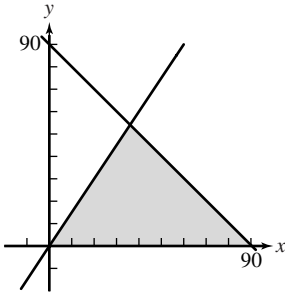

Corner points: $(0, 0)$
 $(90, 0)$, the x -intercept of $x + y = 90$
 $\left(\frac{45}{2}, \frac{135}{2}\right)$, the intersection of $x + y = 90$
 and $3x - y = 0$

(x, y)	$(0, 0)$	$(90, 0)$	$\left(\frac{45}{2}, \frac{135}{2}\right)$
f	0	900	967.5

$$f_{\min} = 0 \text{ [at } (0, 0)\text{]}; f_{\max} = 967.5 \text{ [at } \left(\frac{45}{2}, \frac{135}{2}\right)\text{]}$$

33.

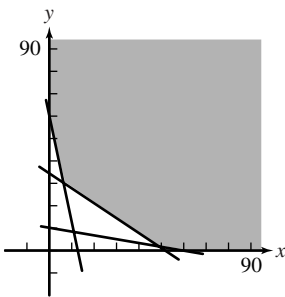

Corner points: $(0, 60)$ y -intercept of $5x + y = 60$
 $(6, 30)$ intersection of $5x + y = 60$ and
 $4x + 6y = 204$
 $(48, 2)$ intersection of $4x + 6y = 204$ and
 $x + 6y = 60$
 $(60, 0)$ x -intercept of $x + 6y = 60$

(x, y)	$(0, 60)$	$(6, 30)$	$(48, 2)$	$(60, 0)$
f	240	162	344	420

$$f_{\min} = 162 \text{ [at } (6, 30)\text{]}; f_{\max} = \text{none (region is unbounded)}$$

34.

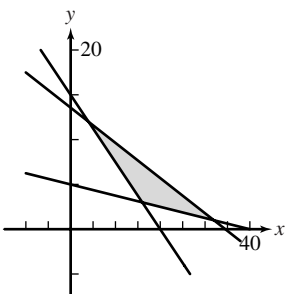

Corner points: $(16, 3)$ intersection of $3x + 4y = 60$ and
 $x + 8y = 40$
 $(4, 12)$ intersection of $3x + 4y = 60$ and
 $11x + 28y = 380$
 $(32, 1)$ intersection of $x + 8y = 40$ and
 $11x + 28y = 380$

(x, y)	$(4, 12)$	$(16, 3)$	$(32, 1)$
f	360	315	505

$$f_{\min} = 315 \text{ [at } (16, 3)\text{]}; f_{\max} = 505 \text{ [at } (32, 1)\text{]}$$

35.

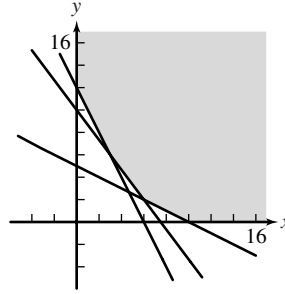

Corner points: $(0, 12)$ y -intercept of $2x + y = 12$
 $(3, 6)$ intersection of $2x + y = 12$ and
 $4x + 3y = 30$
 $(6, 2)$ intersection of $4x + 3y = 30$ and
 $x + 2y = 10$
 $(10, 0)$ x -intercept of $x + 2y = 10$

(x, y)	$(0, 12)$	$(3, 6)$	$(6, 2)$	$(10, 0)$
f	24	27	34	50

$$f_{\min} = 24 \text{ [at } (0, 12)\text{]}; f_{\max} = \text{none (region is unbounded)}$$

36.

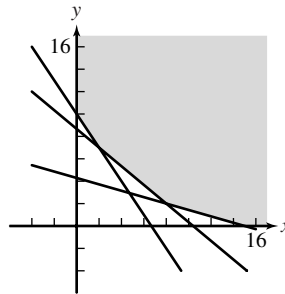

Corner points: $(0, 10)$ y -intercept of $3x + 2y = 20$
 $(2, 7)$ intersection of $3x + 2y = 20$ and
 $5x + 6y = 52$
 $(8, 2)$ intersection of $5x + 6y = 52$ and
 $2x + 7y = 30$
 $(15, 0)$ x -intercept of $2x + 7y = 30$

(x, y)	$(0, 10)$	$(2, 7)$	$(8, 2)$	$(15, 0)$
f	50	41	34	45

$$f_{\min} = 34 \text{ [at } (8, 2)\text{]}; f_{\max} = \text{none (region is unbounded)}$$

For #37–40, first set up the equations; then solve.

 37. Let x = number of tons of ore R
 y = number of tons of ore S
 C = total cost = $50x + 60y$, the objective function

 $80x + 140y \geq 4000$ At least 4000 lb of mineral A
 $160x + 50y \geq 3200$ At least 3200 lb of mineral B
 $x \geq 0, y \geq 0$

The region of feasible points is the intersection of
 $80x + 140y \geq 4000$ and $160x + 50y \geq 3200$ in the first
 quadrant. The region has three corner points: $(0, 64)$,
 $(13.48, 20.87)$, and $(50, 0)$. $C_{\min} = \$1,926.20$ when 13.48
 tons of ore R and 20.87 tons of ore S are processed.

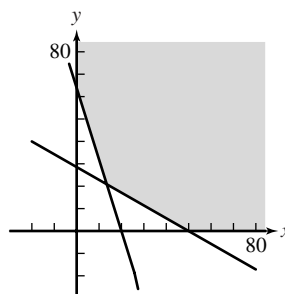

38. Let x = number of units of food substance A
 y = number of units of food substance B
 C = total cost = $1.40x + 0.90y$, the objective function
 $3x + 2y \geq 24$ At least 24 units of carbohydrates
 $4x + y \geq 16$ At least 16 units of protein
 $x \geq 0, y \geq 0$

The region of feasible points is the intersection of $3x + 2y \geq 24$ and $4x + y \geq 16$ in the first quadrant. The corner points are $(0, 16)$, $(1.6, 9.6)$, and $(8, 0)$. $C_{\min} = \$10.88$ when 1.6 units of food substance A and 9.6 units of food substance B are purchased.

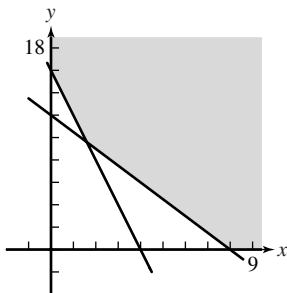

39. Let x = number of operations performed by Refinery 1
 y = number of operations performed by Refinery 2
 C = total cost = $300x + 600y$, the objective function
 $x + y \geq 100$ At least 100 units of grade A
 $2x + 4y \geq 320$ At least 320 units of grade B
 $x + 4y \geq 200$ At least 200 units of grade C
 $x \geq 0, y \geq 0$
- The region of feasible points is the intersection of $x + y \geq 100$, $2x + 4y \geq 320$, and $x + 4y \geq 200$ in the first quadrant. The corners are $(0, 100)$, $(40, 60)$, $(120, 20)$, and $(200, 0)$. $C_{\min} = \$48,000$, which can be obtained by using Refinery 1 to perform 40 operations and Refinery 2 to perform 60 operations, or using Refinery 1 to perform 120 operations and Refinery 2 to perform 20 operations, or any other combination of x and y such that $2x + 4y = 320$ with $40 \leq x \leq 120$.

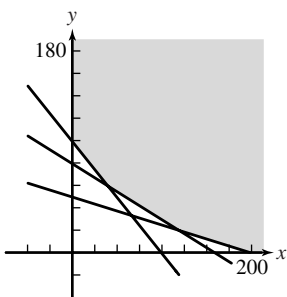

40. Let x = units produced of product A
 y = units produced of product B
 P = total profit = $2.25x + 2.00y$
 $x + y \leq 3000$ No more than 3000 units produced
 $y \geq \frac{1}{2}x$
 $x \geq 0, y \geq 0$

The region of feasible points is the intersection of $x + y \leq 3000$ and $\frac{1}{2}x - y \leq 0$ in the first quadrant. The corners are $(0, 3000)$, $(2000, 1000)$ and $(0, 0)$. $P_{\max} = \$6,500$ when 2000 units of product A and 1000 units of product B are produced.

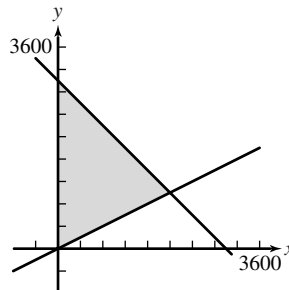

41. False. The graph is a half-plane.
42. True. The half-plane determined by the inequality $2x - 3y < 5$ is bounded by the graph of the equation $2x - 3y = 5$, or equivalently, $3y = 2x - 5$.
43. The graph of $3x + 4y \geq 5$ is Regions I and II plus the boundary. The graph of $2x - 3y \leq 4$ is Regions I and IV plus the boundary. And the intersection of the regions is the graph of the system. The answer is A.
44. The graph of $3x + 4y < 5$ is Regions III and IV without the boundary. The graph of $2x - 3y > 4$ is Regions II and III without the boundary. And the intersection of the regions is the graph of the system. The answer is C.
45. $(3, 4)$ fails to satisfy $x + 3y \leq 12$. The answer is D.
46. At $(3.6, 2.8)$, $f = 46$. The answer is D.
47. (a) One possible answer: Two lines are parallel if they have exactly the same slope. Let l_1 be $5x + 8y = a$ and l_2 be $5x + 8y = b$. Then l_1 becomes $y = \frac{-5}{8}x + \frac{a}{8}$ and l_2 becomes $y = \frac{-5}{8}x + \frac{b}{8}$. Since $M_{l_1} = \frac{-5}{8} = M_{l_2}$, the lines are parallel.
- (b) One possible answer: If two lines are parallel, then a line l_2 going through the point $(0, 10)$ will be further away from the origin than a line l_1 going through the point $(0, 5)$. In this case f_1 could be expressed as $mx + 5$ and f_2 could be expressed as $mx + 10$. Thus, l is moving further away from the origin as f increases.
- (c) One possible answer: The region is bounded and includes all its boundary points.
48. Two parabolas can intersect at no points, exactly one point, two points, or infinitely many points.
 None: $y_1 = x^2$ and $y_2 = x^2 + 1$
 One point: $y_1 = x^2$ and $y_2 = -x^2$
 Two points: $y_1 = x^2$ and $y_2 = \frac{1}{4}x^2 + 4$

49. $4x^2 + 9y^2 = 36$
 $9y^2 = 36 - 4x^2$
 $y^2 = 4 - \frac{4}{9}x^2$
 $y_1 = \sqrt{4 - \frac{4}{9}x^2} = 2\sqrt{1 - \frac{x^2}{9}}$
 $y_2 = -\sqrt{4 - \frac{4}{9}x^2} = -2\sqrt{1 - \frac{x^2}{9}}$

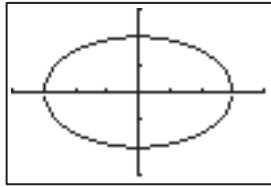

$[-4, 4]$ by $[-3, 3]$

50. $y^2 = x^2 - 4$
 $y_1 = \sqrt{x^2 - 4}$
 $y_2 = -\sqrt{x^2 - 4}$

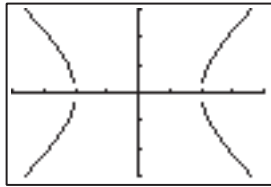

$[-4, 4]$ by $[-3, 3]$

51. $4x^2 + 9y^2 \leq 36$
 $9y^2 \leq 36 - 4x^2$
 $y^2 \leq \frac{36 - 4x^2}{9}$
 $y_1 \leq \sqrt{\frac{36 - 4x^2}{9}}$
 $y_2 \geq -\sqrt{\frac{36 - 4x^2}{9}}$
 $y_3 \geq x^2 - 1$

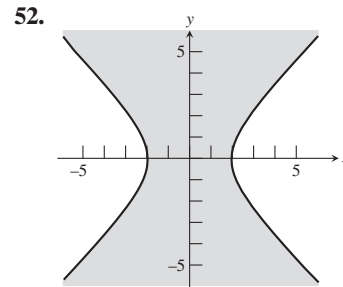
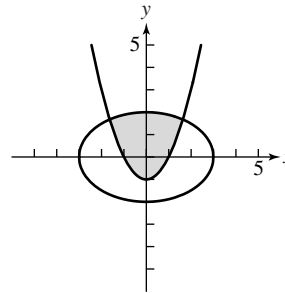

Chapter 7 Review

1. (a) $\begin{bmatrix} 1 & 2 \\ 8 & 3 \end{bmatrix}$ (b) $\begin{bmatrix} -3 & 4 \\ 0 & -3 \end{bmatrix}$ (c) $\begin{bmatrix} 2 & -6 \\ -8 & 0 \end{bmatrix}$ (d) $\begin{bmatrix} -7 & 11 \\ 4 & -6 \end{bmatrix}$
 2. (a) $\begin{bmatrix} 1 & 5 & -1 & 6 \\ 3 & 3 & 1 & 0 \\ -2 & 1 & 3 & 4 \end{bmatrix}$ (b) $\begin{bmatrix} 3 & 1 & -1 & -2 \\ -1 & 5 & -5 & -6 \\ 2 & -7 & 1 & -2 \end{bmatrix}$ (c) $\begin{bmatrix} -4 & -6 & 2 & -4 \\ -2 & -8 & 4 & 6 \\ 0 & 6 & -4 & -2 \end{bmatrix}$ (d) $\begin{bmatrix} 8 & 5 & -3 & -2 \\ -1 & 14 & -12 & -15 \\ 4 & -17 & 4 & -3 \end{bmatrix}$

3. $AB = \begin{bmatrix} (-1)(3) + (4)(0) & (-1)(-1) + (4)(-2) & (-1)(5) + (4)(4) \\ (0)(3) + (6)(0) & (0)(-1) + (6)(-2) & (0)(5) + (6)(4) \end{bmatrix} = \begin{bmatrix} -3 & -7 & 11 \\ 0 & -12 & 24 \end{bmatrix}$; BA is not possible.

4. AB is not possible; $BA = \begin{bmatrix} (-2)(-1) + (3)(3) + (1)(4) & (-2)(2) + (3)(-1) + (1)(3) \\ (2)(-1) + (1)(3) + (0)(4) & (2)(2) + (1)(-1) + (0)(3) \\ (-1)(-1) + (2)(3) + (-3)(4) & (-1)(2) + (2)(-1) + (-3)(3) \end{bmatrix} = \begin{bmatrix} 15 & -4 \\ 1 & 3 \\ -5 & -13 \end{bmatrix}$.

5. $AB = [(-1)(5) + (4)(2) \quad (-1)(-3) + (4)(1)] = [3 \ 7]$; BA is not possible.

6. AB is not possible; $BA = \begin{bmatrix} (3)(-1) + (-4)(0) & (3)(1) + (-4)(1) \\ (1)(-1) + (2)(0) & (1)(1) + (2)(1) \\ (3)(-1) + (1)(0) & (3)(1) + (1)(1) \\ (1)(-1) + (1)(0) & (1)(1) + (1)(1) \end{bmatrix} = \begin{bmatrix} -3 & -1 \\ -1 & 3 \\ -3 & 4 \\ -1 & 2 \end{bmatrix}$.

7. $AB = \begin{bmatrix} (0)(2) + (1)(1) + (0)(-2) & (0)(-3) + (1)(2) + (0)(1) & (0)(4) + (1)(-3) + (0)(-1) \\ (1)(2) + (0)(1) + (0)(-2) & (1)(-3) + (0)(2) + (0)(1) & (1)(4) + (0)(-3) + (0)(-1) \\ (0)(2) + (0)(1) + (1)(-2) & (0)(-3) + (0)(2) + (1)(1) & (0)(4) + (0)(-3) + (1)(-1) \end{bmatrix} = \begin{bmatrix} 1 & 2 & -3 \\ 2 & -3 & 4 \\ -2 & 1 & -1 \end{bmatrix}$
 $BA = \begin{bmatrix} (2)(0) + (-3)(1) + (4)(0) & (2)(1) + (-3)(0) + (4)(0) & (2)(0) + (-3)(0) + (4)(1) \\ (1)(0) + (2)(1) + (-3)(0) & (1)(1) + (2)(0) + (-3)(0) & (1)(0) + (2)(0) + (-3)(1) \\ (-2)(0) + (1)(1) + (-1)(0) & (-2)(1) + (1)(0) + (-1)(0) & (-2)(0) + (1)(0) + (-1)(1) \end{bmatrix} = \begin{bmatrix} -3 & 2 & 4 \\ 2 & 1 & -3 \\ 1 & -2 & -1 \end{bmatrix}$

8. As in #7, the multiplication steps take up a lot of space to write, but are easy to carry out, since A contains only 0s and 1s. The intermediate steps are not shown here, but note that the rows of AB are a rearrangement of the rows of B (specifically, rows 1 and 2, and rows 3 and 4, are swapped), while the columns of BA are a rearrangement of the columns of B (we swap columns 1 and 2, and columns 3 and 4). The nature of the rearrangement can be determined by noting the locations of the 1s in A .

$$AB = \begin{bmatrix} 3 & 0 & 2 & 1 \\ -2 & 1 & 0 & 1 \\ 3 & -2 & 1 & 0 \\ -1 & 1 & 2 & -1 \end{bmatrix};$$

$$BA = \begin{bmatrix} 1 & -2 & 1 & 0 \\ 0 & 3 & 1 & 2 \\ 1 & -1 & -1 & 2 \\ -2 & 3 & 0 & 1 \end{bmatrix}$$

9. Carry out the multiplication of AB and BA and confirm that both products equal I_4 .

$$14. \det = \begin{vmatrix} -2 & 3 & 0 & 1 \\ 3 & 0 & 2 & 0 \\ 5 & 2 & -3 & 4 \\ 1 & -1 & 2 & 3 \end{vmatrix} = (3)(-1)^3 \begin{vmatrix} 3 & 0 & 1 \\ 2 & -3 & 4 \\ -1 & 2 & 3 \end{vmatrix} + 0 + 2(-1)^5 \begin{vmatrix} -2 & 3 & 1 \\ 5 & 2 & 4 \\ 1 & -1 & 3 \end{vmatrix} + 0$$

$$= -3 \left[3(-1)^2 \begin{vmatrix} -3 & 4 \\ 2 & 3 \end{vmatrix} + 0 + (1)(-1)^4 \begin{vmatrix} 2 & -3 \\ -1 & 2 \end{vmatrix} \right] - 2 \left[-2(-1)^2 \begin{vmatrix} 2 & 4 \\ -1 & 3 \end{vmatrix} + (3)(-1)^3 \begin{vmatrix} 5 & 4 \\ 1 & 3 \end{vmatrix} + (1)(-1)^4 \begin{vmatrix} 5 & 2 \\ 1 & -1 \end{vmatrix} \right]$$

$$= (-3)(3)(-9 - 8) + (-3)(1)(4 - 3) + (-2)(-2)(6 + 4) + (-2)(-3)(15 - 4) + (-2)(1)(-5 - 2)$$

$$= 153 - 3 + 40 + 66 + 14 = 270$$

For #15–18, one possible sequence of row operations is shown.

$$15. \begin{bmatrix} 1 & 0 & 2 \\ 3 & 1 & 5 \\ 1 & -1 & 3 \end{bmatrix} \xrightarrow{\substack{(-3)R_1 + R_2 \\ (-1)R_1 + R_3}} \begin{bmatrix} 1 & 0 & 2 \\ 0 & 1 & -1 \\ 0 & -1 & 1 \end{bmatrix} \xrightarrow{(1)R_2 + R_3} \begin{bmatrix} 1 & 0 & 2 \\ 0 & 1 & -1 \\ 0 & 0 & 0 \end{bmatrix}$$

$$16. \begin{bmatrix} 2 & 1 & 1 & 1 \\ -3 & -1 & -2 & 1 \\ 5 & 2 & 2 & 3 \end{bmatrix} \xrightarrow{(1/2)R_1} \begin{bmatrix} 1 & 0.5 & 0.5 & 0.5 \\ -3 & -1 & -2 & 1 \\ 5 & 2 & 2 & 3 \end{bmatrix} \xrightarrow{\substack{(3)R_1 + R_2 \\ (-5)R_1 + R_3}} \begin{bmatrix} 1 & 0.5 & 0.5 & 0.5 \\ 0 & 0.5 & -0.5 & 2.5 \\ 0 & -0.5 & -0.5 & 0.5 \end{bmatrix} \xrightarrow{\substack{(1)R_3 + R_1 \\ (1)R_2 + R_3}} \begin{bmatrix} 1 & 0 & 0 & 1 \\ 0 & 1 & 0 & 2 \\ 0 & 0 & 1 & -3 \end{bmatrix}$$

$$17. \begin{bmatrix} 1 & 2 & 3 & 1 \\ 2 & 3 & 3 & -2 \\ 1 & 2 & 4 & 6 \end{bmatrix} \xrightarrow{\substack{(-2)R_1 + R_2 \\ (-1)R_1 + R_3}} \begin{bmatrix} 1 & 2 & 3 & 1 \\ 0 & -1 & -3 & -4 \\ 0 & 0 & 1 & 5 \end{bmatrix} \xrightarrow{\substack{(2)R_2 + R_1 \\ (3)R_3 + R_2}} \begin{bmatrix} 1 & 0 & -3 & -7 \\ 0 & -1 & 0 & 11 \\ 0 & 0 & 1 & 5 \end{bmatrix} \xrightarrow{\substack{(-1)R_2 \\ (3)R_3 + R_1}} \begin{bmatrix} 1 & 0 & 0 & 8 \\ 0 & 1 & 0 & -11 \\ 0 & 0 & 1 & 5 \end{bmatrix}$$

$$18. \begin{bmatrix} 1 & -2 & 0 & 4 \\ -2 & 5 & 3 & -6 \\ 2 & 4 & 1 & 9 \end{bmatrix} \xrightarrow{\substack{(2)R_1 + R_2 \\ (-2)R_1 + R_3}} \begin{bmatrix} 1 & -2 & 0 & 4 \\ 0 & 1 & 3 & 2 \\ 0 & 0 & 1 & 1 \end{bmatrix} \xrightarrow{\substack{(2)R_2 + R_1 \\ (-3)R_3 + R_2}} \begin{bmatrix} 1 & 0 & 6 & 8 \\ 0 & 1 & 0 & -1 \\ 0 & 0 & 1 & 1 \end{bmatrix} \xrightarrow{(-6)R_3 + R_1} \begin{bmatrix} 1 & 0 & 0 & 2 \\ 0 & 1 & 0 & -1 \\ 0 & 0 & 1 & 1 \end{bmatrix}$$

For #19–22, use any of the methods of this chapter. Solving for x (or y) and substituting is probably easiest for these systems.

19. $(x, y) = (1, 2)$: From \mathbf{E}_1 , $y = 3x - 1$; substituting in \mathbf{E}_2 gives $x + 2(3x - 1) = 5$. Then $7x = 7$, so $x = 1$. Finally, $y = 2$.
20. $(x, y) = (-3, -1)$: From \mathbf{E}_1 , $x = 2y - 1$; substituting in \mathbf{E}_2 gives $-2(2y - 1) + y = 5$. Then $-3y = 3$, so $y = -1$. Finally, $x = -3$.
21. No solution: From \mathbf{E}_1 , $x = 1 - 2y$; substituting in \mathbf{E}_2 gives $4y - 4 = -2(1 - 2y)$, or $4y - 4 = 4y - 2$ — which is impossible.

10. Carry out the multiplication of AB and BA and confirm that both products equal I_3 .

11. Using a calculator:

$$\begin{bmatrix} 1 & 2 & 0 & -1 \\ 2 & -1 & 1 & 2 \\ 2 & 0 & 1 & 2 \\ -1 & 1 & 1 & 4 \end{bmatrix}^{-1} = \begin{bmatrix} -2 & -5 & 6 & -1 \\ 0 & -1 & 1 & 0 \\ 10 & 24 & -27 & 4 \\ -3 & -7 & 8 & -1 \end{bmatrix}$$

12. Using a calculator:

$$\begin{bmatrix} -1 & 0 & 1 \\ 2 & -1 & 1 \\ 1 & 1 & 1 \end{bmatrix}^{-1} = \begin{bmatrix} -0.4 & 0.2 & 0.2 \\ -0.2 & -0.4 & 0.6 \\ 0.6 & 0.2 & 0.2 \end{bmatrix}$$

$$13. \det = \begin{vmatrix} 1 & -3 & 2 \\ 2 & 4 & -1 \\ -2 & 0 & 1 \end{vmatrix}$$

$$= (-2)(-1)^4 \begin{vmatrix} -3 & 2 \\ 4 & -1 \end{vmatrix} + 0 + (1)(-1)^6 \begin{vmatrix} 1 & -3 \\ 2 & 4 \end{vmatrix}$$

$$= -2(3 - 8) + (4 - (-6))$$

$$= 10 + 10$$

$$= 20$$

22. No solution: From \mathbf{E}_1 , $x = 2y + 9$; substituting in \mathbf{E}_2

$$\text{gives } 3y - \frac{3}{2}(2y + 9) = -9, \text{ or } -\frac{27}{2} = -9 \text{ — which is not true.}$$

23. $(x, y, z, w) = (2 - z - w, w + 1, z, w)$: Note that the last equation in the triangular system is not useful. z and w can be anything, then $y = w + 1$ and $x = 2 - z - w$.

$$\begin{array}{l} x + z + w = 2 \\ x + y + z = 3 \Rightarrow \mathbf{E}_2 - \mathbf{E}_1 \Rightarrow \\ 3x + 2y + 3z + w = 8 \Rightarrow \mathbf{E}_3 - 3\mathbf{E}_1 \Rightarrow \end{array} \quad \begin{array}{l} x + z + w = 2 \\ y - w = 1 \\ 2y - 2w = 2 \Rightarrow \mathbf{E}_3 - 2\mathbf{E}_2 \Rightarrow \end{array} \quad \begin{array}{l} x + z + w = 2 \\ y - w = 1 \\ 0 = 0 \end{array}$$

24. $(x, y, z, w) = (-w - 2, -z - w, z, w)$: Note that the last equation in the triangular system is not useful. z and w can be anything, then $y = -z - w$ and $x = -w - 2$.

$$\begin{array}{l} x + w = -2 \\ x + y + z + 2w = -2 \Rightarrow \mathbf{E}_2 - \mathbf{E}_1 \Rightarrow \\ -x - 2y - 2z - 3w = 2 \Rightarrow \mathbf{E}_3 + 2\mathbf{E}_2 \Rightarrow \end{array} \quad \begin{array}{l} x + w = -2 \\ y + z + w = 0 \\ x + w = -2 \Rightarrow \mathbf{E}_3 - \mathbf{E}_1 \Rightarrow \end{array} \quad \begin{array}{l} x + w = -2 \\ y + z + w = 0 \\ 0 = 0 \end{array}$$

25. No solution: \mathbf{E}_1 and \mathbf{E}_3 are inconsistent.

$$\begin{array}{l} x + y - 2z = 2 \\ 3x - y + z = 4 \\ -2x - 2y + 4z = 6 \Rightarrow \mathbf{E}_3 + 2\mathbf{E}_1 \Rightarrow \end{array} \quad \begin{array}{l} x + y - 2z = 2 \\ 3x - y + z = 4 \\ 0 = 10 \end{array}$$

26. $(x, y, z) = \left(\frac{1}{4}z + \frac{3}{4}, \frac{7}{4}z + \frac{5}{4}, z\right)$: Note that the last equation in the triangular system is not useful. z can be anything,

$$\text{then } y = \frac{7}{4}z + \frac{5}{4} \text{ and } x = 2 + 2z - \left(\frac{7}{4}z + \frac{5}{4}\right) = \frac{1}{4}z + \frac{3}{4}.$$

$$\begin{array}{l} x + y - 2z = 2 \\ 3x - y + z = 1 \Rightarrow \mathbf{E}_2 - 3\mathbf{E}_1 \Rightarrow \\ -2x - 2y + 4z = -4 \Rightarrow \mathbf{E}_3 + 2\mathbf{E}_1 \Rightarrow \end{array} \quad \begin{array}{l} x + y - 2z = 2 \\ -4y + 7z = -5 \\ 0 = 0 \end{array}$$

27. $(x, y, z, w) = (1 - 2z + w, 2 + z - w, z, w)$: Note that the last two equations in the triangular system give no additional information. z and w can be anything, then $y = 2 + z - w$ and $x = 13 - 6(2 + z - w) + 4z - 5w = 1 - 2z + w$.

$$\begin{array}{l} -x - 6y + 4z - 5w = -13 \\ 2x + y + 3z - w = 4 \Rightarrow \mathbf{E}_2 + 2\mathbf{E}_1 \Rightarrow \\ 2x + 2y + 2z = 6 \Rightarrow \mathbf{E}_3 + 2\mathbf{E}_1 \Rightarrow \\ -x - 3y + z - 2w = -7 \Rightarrow \mathbf{E}_4 - \mathbf{E}_1 \Rightarrow \end{array} \quad \begin{array}{l} -x - 6y + 4z - 5w = -13 \\ -11y + 11z - 11w = -22 \Rightarrow -\frac{1}{11}\mathbf{E}_2 \Rightarrow \\ -10y + 10z - 10w = -20 \Rightarrow -\frac{1}{10}\mathbf{E}_3 \Rightarrow \\ 3y - 3z + 3w = 6 \Rightarrow \frac{1}{3}\mathbf{E}_4 \Rightarrow \end{array} \quad \begin{array}{l} -x - 6y + 4z - 5w = -13 \\ y - z + w = 2 \\ y - z + w = 2 \\ y - z + w = 2 \end{array}$$

28. $(x, y, z, w) = (-w + 2, -z - 1, z, w)$: Note that the last two equations in the triangular system give no additional information. z and w can be anything, then $y = -z - 1$ and $x = 4 + 2(-z - 1) + 2z - w = 2 - w$.

$$\begin{array}{l} -x + 2y + 2z - w = -4 \\ y + z = -1 \\ -2x + 2y + 2z - 2w = -6 \Rightarrow \mathbf{E}_3 - 2\mathbf{E}_1 \Rightarrow \\ -x + 3y + 3z - w = -5 \Rightarrow \mathbf{E}_4 - \mathbf{E}_1 \Rightarrow \end{array} \quad \begin{array}{l} -x + 2y + 2z - w = -4 \\ y + z = -1 \\ -2y - 2z = 2 \Rightarrow -\frac{1}{2}\mathbf{E}_3 \Rightarrow \\ y + z = -1 \end{array} \quad \begin{array}{l} -x + 2y + 2z - w = -4 \\ y + z = -1 \\ y + z = -1 \\ y + z = -1 \end{array}$$

$$29. (x, y, z) = \left(\frac{9}{4}, -\frac{3}{4}, -\frac{7}{4}\right): \begin{bmatrix} x \\ y \\ z \end{bmatrix} = \begin{bmatrix} 1 & 2 & 1 \\ 1 & -3 & 2 \\ 2 & -3 & 1 \end{bmatrix}^{-1} \begin{bmatrix} -1 \\ 1 \\ 5 \end{bmatrix} = \frac{1}{12} \begin{bmatrix} 3 & -5 & 7 \\ 3 & -1 & -1 \\ 3 & 7 & -5 \end{bmatrix} \begin{bmatrix} -1 \\ 1 \\ 5 \end{bmatrix}.$$

$$30. (x, y, z) = \left(\frac{1}{2}, -\frac{5}{2}, -\frac{5}{2}\right): \begin{bmatrix} x \\ y \\ z \end{bmatrix} = \begin{bmatrix} 1 & 2 & -1 \\ 2 & -1 & 1 \\ 1 & 1 & -2 \end{bmatrix}^{-1} \begin{bmatrix} -2 \\ 1 \\ 3 \end{bmatrix} = \frac{1}{8} \begin{bmatrix} 1 & 3 & 1 \\ 5 & -1 & -3 \\ 3 & 1 & -5 \end{bmatrix} \begin{bmatrix} -2 \\ 1 \\ 3 \end{bmatrix}.$$

31. There is no inverse, since the coefficient matrix, shown on the right, has determinant 0 (found with a calculator). Note that this does not necessarily mean there is no solution — there may be infinitely many solutions. However, by other means one can determine that there is no solution in this case.

$$\begin{bmatrix} 2 & 1 & 1 & -1 \\ 2 & -1 & 1 & -1 \\ -1 & 1 & -1 & 1 \\ 1 & -2 & 1 & -1 \end{bmatrix}$$

$$32. (x, y, z, w) = \left(\frac{13}{3}, -\frac{8}{3}, -\frac{1}{3}, \frac{22}{3}\right): \begin{bmatrix} x \\ y \\ z \\ w \end{bmatrix} = \begin{bmatrix} 1 & -2 & 1 & -1 \\ 2 & 1 & -1 & -1 \\ 1 & -1 & 2 & -1 \\ 1 & 3 & -1 & 1 \end{bmatrix}^{-1} \begin{bmatrix} 2 \\ -1 \\ -1 \\ 4 \end{bmatrix} = \frac{1}{9} \begin{bmatrix} 8 & -1 & -2 & 5 \\ -7 & 2 & 4 & -1 \\ -2 & -2 & 5 & 1 \\ 11 & -7 & -5 & 8 \end{bmatrix} \begin{bmatrix} 2 \\ -1 \\ -1 \\ 4 \end{bmatrix}$$

33. $(x, y, z, w) = (2 - w, z + 3, z, w)$ — z and w can be anything:

$$\begin{bmatrix} 1 & 2 & -2 & 1 & 8 \\ 2 & 3 & -3 & 2 & 13 \end{bmatrix} \xrightarrow{(-2)R_1 + R_2} \begin{bmatrix} 1 & 2 & -2 & 1 & 8 \\ 0 & -1 & 1 & 0 & -3 \end{bmatrix} \xrightarrow{\begin{matrix} (2)R_2 + R_1 \\ (-1)R_2 \end{matrix}} \begin{bmatrix} 1 & 0 & 0 & 1 & 2 \\ 0 & 1 & -1 & 0 & 3 \end{bmatrix}$$

34. $(x, y, z, w) = (2 - w, z + 3, z, w)$ — z and w can be anything. The final step, $(-1)R_2 + R_3$, is not shown:

$$\begin{bmatrix} 1 & 2 & -2 & 1 & 8 \\ 2 & 7 & -7 & 2 & 25 \\ 1 & 3 & -3 & 1 & 11 \end{bmatrix} \xrightarrow{\begin{matrix} (-2)R_1 + R_2 \\ (-1)R_1 + R_3 \end{matrix}} \begin{bmatrix} 1 & 2 & -2 & 1 & 8 \\ 0 & 3 & -3 & 0 & 9 \\ 0 & 1 & -1 & 0 & 3 \end{bmatrix} \xrightarrow{\begin{matrix} (1/3)R_2 \\ (-2)R_3 + R_1 \end{matrix}} \begin{bmatrix} 1 & 0 & 0 & 1 & 2 \\ 0 & 1 & -1 & 0 & 3 \\ 0 & 1 & -1 & 0 & 3 \end{bmatrix}$$

35. $(x, y, z, w) = (-2, 1, 3, -1)$:

$$\begin{bmatrix} 1 & 2 & 4 & 6 & 6 \\ 3 & 4 & 8 & 11 & 11 \\ 2 & 4 & 7 & 11 & 10 \\ 3 & 5 & 10 & 14 & 15 \end{bmatrix} \xrightarrow{\begin{matrix} (-2)R_1 + R_3 \\ R_{24} \end{matrix}} \begin{bmatrix} 1 & 2 & 4 & 6 & 6 \\ 3 & 5 & 10 & 14 & 15 \\ 0 & 0 & -1 & -1 & -2 \\ 3 & 4 & 8 & 11 & 11 \end{bmatrix} \xrightarrow{\begin{matrix} (-1)R_4 + R_2 \\ (-1)R_3 \end{matrix}}$$

$$\begin{bmatrix} 1 & 2 & 4 & 6 & 6 \\ 0 & 1 & 2 & 3 & 4 \\ 0 & 0 & 1 & 1 & 2 \\ 3 & 4 & 8 & 11 & 11 \end{bmatrix} \xrightarrow{\begin{matrix} (-2)R_2 + R_1 \\ (-4)R_2 + R_4 \end{matrix}} \begin{bmatrix} 1 & 0 & 0 & 0 & -2 \\ 0 & 1 & 2 & 3 & 4 \\ 0 & 0 & 1 & 1 & 2 \\ 3 & 0 & 0 & -1 & -5 \end{bmatrix} \xrightarrow{\begin{matrix} (-3)R_1 + R_4 \\ (-2)R_3 + R_2 \end{matrix}} \begin{bmatrix} 1 & 0 & 0 & 0 & -2 \\ 0 & 1 & 0 & 1 & 0 \\ 0 & 0 & 1 & 1 & 2 \\ 0 & 0 & 0 & -1 & 1 \end{bmatrix}$$

$$\xrightarrow{\begin{matrix} (1)R_4 + R_2 \\ (1)R_4 + R_3 \end{matrix}} \begin{bmatrix} 1 & 0 & 0 & 0 & -2 \\ 0 & 1 & 0 & 0 & 1 \\ 0 & 0 & 1 & 0 & 3 \\ 0 & 0 & 0 & -1 & 1 \end{bmatrix} \xrightarrow{(-1)R_4} \begin{bmatrix} 1 & 0 & 0 & 0 & -2 \\ 0 & 1 & 0 & 0 & 1 \\ 0 & 0 & 1 & 0 & 3 \\ 0 & 0 & 0 & 1 & -1 \end{bmatrix}$$

36. $(x, y, z, w) = (1, -w - 3, w + 2, w)$:

$$\begin{bmatrix} 1 & 0 & 2 & -2 & 5 \\ 2 & 1 & 4 & -3 & 7 \\ 4 & 1 & 7 & -6 & 15 \\ 2 & 1 & 5 & -4 & 9 \end{bmatrix} \xrightarrow{\begin{matrix} (-4)R_1 + R_3 \\ (-1)R_2 + R_4 \end{matrix}} \begin{bmatrix} 1 & 0 & 2 & -2 & 5 \\ 2 & 1 & 4 & -3 & 7 \\ 0 & 1 & -1 & 2 & -5 \\ 0 & 0 & 1 & -1 & 2 \end{bmatrix}$$

$$\xrightarrow{\begin{matrix} (-2)R_1 + R_2 \\ (-2)R_4 + R_1 \end{matrix}} \begin{bmatrix} 1 & 0 & 0 & 0 & 1 \\ 0 & 1 & 0 & 1 & -3 \\ 0 & 1 & -1 & 2 & -5 \\ 0 & 0 & 1 & -1 & 2 \end{bmatrix} \xrightarrow{(-1)R_2 + R_3} \begin{bmatrix} 1 & 0 & 0 & 0 & 1 \\ 0 & 1 & 0 & 1 & -3 \\ 0 & 0 & -1 & 1 & -2 \\ 0 & 0 & 1 & -1 & 2 \end{bmatrix} \xrightarrow{\begin{matrix} (1)R_3 + R_4 \\ (-1)R_3 \end{matrix}}$$

$$\begin{bmatrix} 1 & 0 & 0 & 0 & 1 \\ 0 & 1 & 0 & 1 & -3 \\ 0 & 0 & 1 & -1 & 2 \\ 0 & 0 & 0 & 0 & 0 \end{bmatrix}$$

37. $(x, p) \approx (7.57, 42.71)$: Solve $100 - x^2 = 20 + 3x$ to give $x \approx 7.57$ (the other solution, $x \approx -10.57$, makes no sense in this problem). Then $p = 20 + 3x \approx 42.71$.

38. $(x, p) \approx (13.91, 60.65)$: Solve $80 - \frac{1}{10}x^2 = 5 + 4x$ to give $x \approx 13.91$ (the other solution, $x \approx -53.91$, makes no sense in this problem). Then $p = 5 + 4x \approx 60.65$.

39. $(x, y) \approx (0.14, -2.29)$

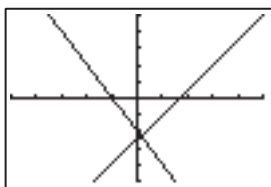

$[-5, 5]$ by $[-5, 5]$

40. $(x, y) = (-1, -2.5)$ or $(x, y) = (3, 1.5)$

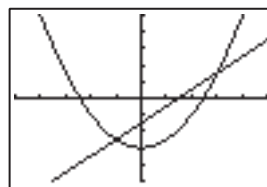

$[-5, 5]$ by $[-5, 5]$

41. $(x, y) = (-2, 1)$ or $(x, y) = (2, 1)$

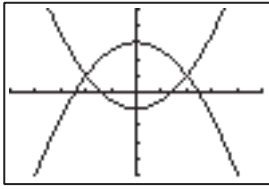

[-5, 5] by [-5, 5]

42. $(x, y) \approx (-1.47, 1.35)$ or $(x, y) \approx (1.47, 1.35)$ or $(x, y) \approx (0.76, -1.85)$ or $(x, y) \approx (-0.76, -1.85)$

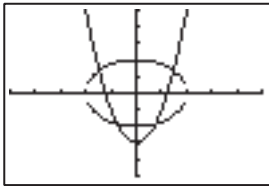

[-5, 5] by [-5, 5]

43. $(x, y) \approx (2.27, 1.53)$

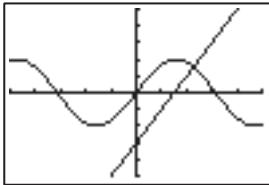

[-5, 5] by [-5, 5]

44. $(x, y) \approx (4.62, 2.22)$ or $(x, y) \approx (1.56, 1.14)$

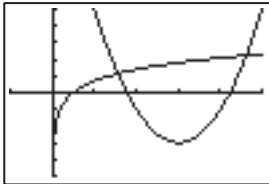

[-1, 5] by [-5, 5]

45. $(a, b, c, d) = \left(\frac{17}{840}, -\frac{33}{280}, -\frac{571}{420}, \frac{386}{35}\right)$
 $= (0.020\dots, -0.117\dots, -1.359\dots, 11.028\dots)$. In matrix form, the system is as shown below. Use a calculator to find the inverse matrix and multiply.

$$\begin{bmatrix} 8 & 4 & 2 & 1 \\ 64 & 16 & 4 & 1 \\ 216 & 36 & 6 & 1 \\ 729 & 81 & 9 & 1 \end{bmatrix} \begin{bmatrix} a \\ b \\ c \\ d \end{bmatrix} = \begin{bmatrix} 8 \\ 5 \\ 3 \\ 4 \end{bmatrix}$$

46. $(a, b, c, d, e) = \left(\frac{19}{108}, -\frac{29}{18}, \frac{59}{36}, \frac{505}{54}, -\frac{68}{9}\right)$
 $= (0.1759\bar{2}, -1.6\bar{1}, 1.63\bar{8}, 9.35\bar{1}8, -7.\bar{5})$. In matrix form, the system is as shown below. Use a calculator to find the inverse matrix and multiply.

$$\begin{bmatrix} 16 & -8 & 4 & -2 & 1 \\ 1 & 1 & 1 & 1 & 1 \\ 81 & 27 & 9 & 3 & 1 \\ 256 & 64 & 16 & 4 & 1 \\ 2401 & 343 & 49 & 7 & 1 \end{bmatrix} \begin{bmatrix} a \\ b \\ c \\ d \\ e \end{bmatrix} = \begin{bmatrix} -4 \\ 2 \\ 6 \\ -2 \\ 8 \end{bmatrix}$$

47. $\frac{3x-2}{x^2-3x-4} = \frac{A_1}{x+1} + \frac{A_2}{x-4}$, so $3x-2 = A_1(x-4) + A_2(x+1)$. With $x = -1$, we see that $-5 = -5A_1$, so $A_1 = 1$; with $x = 4$ we have $10 = 5A_2$, so $A_2 = 2$: $\frac{1}{x+1} + \frac{2}{x-4}$.

48. $\frac{x-16}{x^2+x-2} = \frac{A_1}{x+2} + \frac{A_2}{x-1}$, so $x-16 = A_1(x-1) + A_2(x+2)$. With $x = -2$, we see that $-18 = -3A_1$, so $A_1 = 6$; with $x = 1$ we have $-15 = 3A_2$, so $A_2 = -5$: $\frac{6}{x+2} - \frac{5}{x-1}$.

49. The denominator factors into $(x+2)(x+1)^2$, so $\frac{3x+5}{x^3+4x^2+5x+2} = \frac{A_1}{x+2} + \frac{A_2}{x+1} + \frac{A_3}{(x+1)^2}$. Then $3x+5 = A_1(x+1)^2 + A_2(x+2)(x+1) + A_3(x+2)$. With $x = -2$, we have $-1 = A_1$; with $x = -1$, we have $2 = A_3$; with $x = 0$, we have $5 = A_1 + 2A_2 + 2A_3 = -1 + 2A_2 + 4$, so that $A_2 = 1$: $-\frac{1}{x+2} + \frac{1}{x+1} + \frac{2}{(x+1)^2}$.

50. The denominator factors into $(x-1)(x+2)^2$, so $\frac{3(3+2x+x^2)}{x^3+3x^2-4} = \frac{A_1}{x-1} + \frac{A_2}{x+2} + \frac{A_3}{(x+2)^2}$. Then $3x^2+6x+9 = A_1(x+2)^2 + A_2(x-1)(x+2) + A_3(x-1)$. With $x = 1$, we have $18 = 9A_1$, so $A_1 = 2$; with $x = -2$, we have $9 = -3A_3$, so $A_3 = -3$; with $x = 0$, we have $9 = 4A_1 - 2A_2 - A_3 = 8 - 2A_2 + 3$, so that $A_2 = 1$: $\frac{2}{x-1} + \frac{1}{x+2} - \frac{3}{(x+2)^2}$.

51. The denominator factors into $(x+1)(x^2+1)$, so $\frac{5x^2-x-2}{x^3+x^2+x+1} = \frac{A}{x+1} + \frac{Bx+C}{x^2+1}$. Then $5x^2-x-2 = A(x^2+1) + (Bx+C)(x+1)$. With $x = -1$, we have $4 = 2A$, so $A = 2$; with $x = 0$, $-2 = A + C$, so $C = -4$. Finally, with $x = 1$ we have $2 = 2A + (B+C)(2) = 4 + 2B - 8$, so that $B = 3$: $\frac{2}{x+1} + \frac{3x-4}{x^2+1}$.

52. The denominator factors into $(x+2)(x^2+4)$, so $\frac{-x^2-5x+2}{x^3+2x^2+4x+8} = \frac{A}{x+2} + \frac{Bx+C}{x^2+4}$. Then $-x^2-5x+2 = A(x^2+4) + (Bx+C)(x+2)$. With $x = -2$, we have $8 = 8A$, so $A = 1$, with $x = 0$, $2 = 4A + 2C$, so $C = -1$. Finally, with $x = 1$ we have $-4 = 5A + (B+C)(3) = 5 + 3B - 3$, so that $B = -2$: $\frac{1}{x+2} - \frac{2x+1}{x^2+4}$.

53. (c)

54. (d)

55. (b)

56. (a)

57.

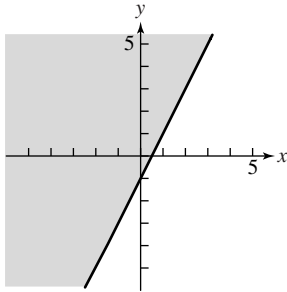

58.

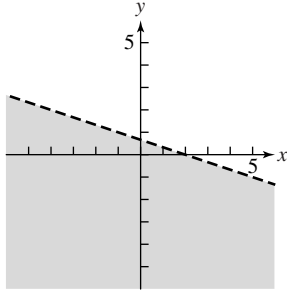

59. Corner points: $(0, 90)$, $(90, 0)$, $(\frac{360}{13}, \frac{360}{13})$. Boundaries included.

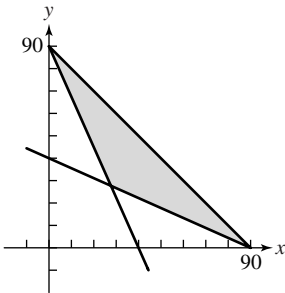

60. Corner points: $(0, 3)$, $(0, 7)$, $(\frac{30}{13}, \frac{70}{13})$, $(3, 0)$, $(5, 0)$. Boundaries included.

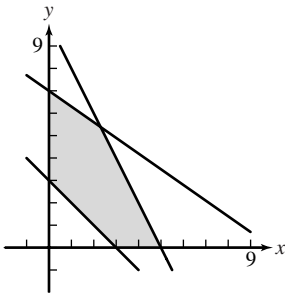

61. Corner points: approx. $(0.92, 2.31)$ and $(5.41, 3.80)$. Boundaries excluded.

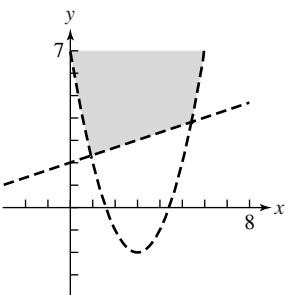

62. Corner points: approx. $(-2.41, 3.20)$ and $(2.91, 0.55)$. Boundaries included.

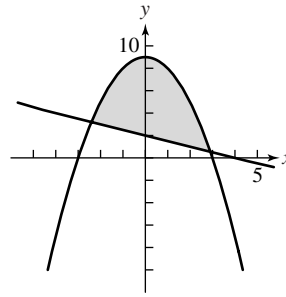

63. Corner points: approx. $(-1.25, 1.56)$ and $(1.25, 1.56)$. Boundaries included.

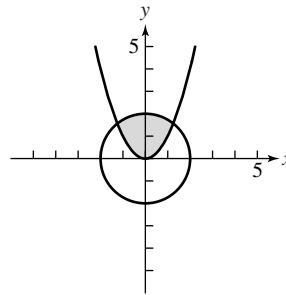

64. No corner points. Boundaries included.

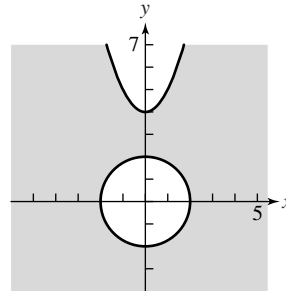

65. Corner points: $(0, 20)$, $(25, 0)$, and $(10, 6)$.

(x, y)	$(0, 20)$	$(10, 6)$	$(25, 0)$
f	120	106	175

 $f_{\min} = 106$ [at $(10, 6)$]; $f_{\max} = \text{none (unbounded)}$

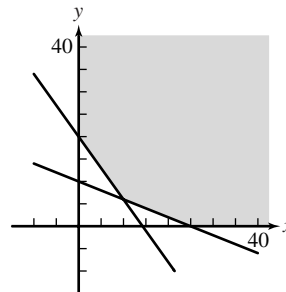

66. Corner points: (0, 30), (8, 10), and (24, 0).

(x, y)	(0, 30)	(8, 10)	(24, 0)
----------	---------	---------	---------

f	150	138	264
-----	-----	-----	-----

$f_{\min} = 138$ [at (8, 10)]; $f_{\max} = \text{none (unbounded)}$

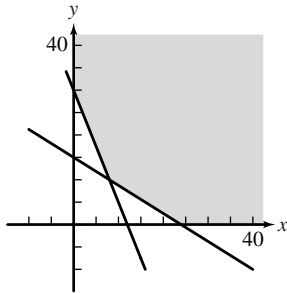

67. Corner points: (4, 40), (10, 25), and (70, 10).

(x, y)	(4, 40)	(10, 25)	(70, 10)
----------	---------	----------	----------

f	292	205	280
-----	-----	-----	-----

$f_{\min} = 205$ [at (10, 25)]; $f_{\max} = 292$ [at (4, 40)]

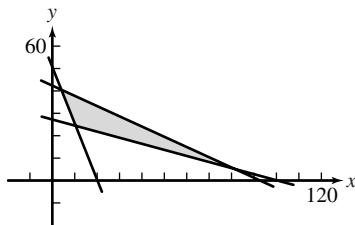

68. Corner points: (0, 120), (120, 0), and (20, 30).

(x, y)	(0, 120)	(120, 0)	(20, 30)
----------	----------	----------	----------

f	1680	1080	600
-----	------	------	-----

$f_{\min} = 600$ [at (20, 30)]; $f_{\max} = 1680$ [at (0, 120)]

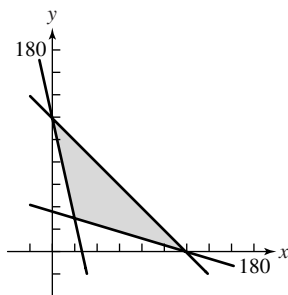

69. (a) $\begin{bmatrix} 1 & 2 \\ \cos 45^\circ & -\sin 45^\circ \\ \sin 45^\circ & \cos 45^\circ \end{bmatrix} \approx \begin{bmatrix} 2.12 \\ 0.71 \end{bmatrix}$

(b) $\begin{bmatrix} 1 & 2 \\ \cos 45^\circ & \sin 45^\circ \\ -\sin 45^\circ & \cos 45^\circ \end{bmatrix} \approx \begin{bmatrix} -0.71 \\ 2.12 \end{bmatrix}$

70. In this problem, the graphs are representative of the total Medicare Disbursements (in billions of dollars) for several years, where x is the number of years past 1990.

- (a) The following is a scatter plot of the data with the linear regression equation $y = 11.4428x + 116.681$ superimposed on it.

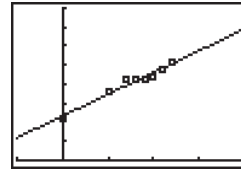

[-5, 20] by [0, 400]

- (b) The following is a scatter plot of the data with the logistic regression equation $y = \frac{294.846}{1 + 1.6278e^{-0.1784x}}$ superimposed on it.

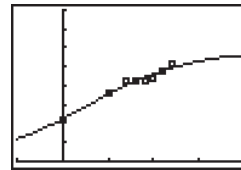

[-5, 20] by [0, 400]

- (c) *Graphical solution:* The two regression models will predict the same disbursement amounts when the graph of their difference is 0. That will occur when the graph crosses the x -axis. This difference function is $y = 11.4428x + 116.681 - \left(\frac{294.846}{1 + 1.6278e^{-0.1784x}} \right)$ and it crosses the x -axis when $x \approx 3.03$ and $x \approx 10.15$.

The disbursement amount of the two models will be the same sometime in the years 1993 and 2000.

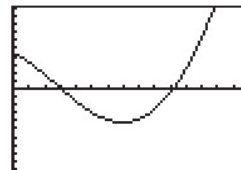

[0, 15] by [-10, 10]

Another graphical solution would be to find where the graphs of the two curves intersect.

Algebraic solution: The algebraic solution of the problem is not feasible.

- (d) Both models appear to fit the data fairly well. The logistic model should be used to make predictions beyond 2000. The disbursements stabilize using the logistic model but continue to rise according to the linear model.

71. In this problem, the graphs are representative of the population (in thousands) of the states of Hawaii and Idaho for several years, where x is the number of years past 1980.

- (a) The following is a scatter plot of the Hawaii data with the linear regression equation $y = 12.2614x + 979.5909$ superimposed on it.

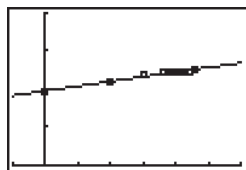

[-5, 30] by [0, 2000]

- (b) The following is a scatter plot of the Idaho data with the linear regression equation $y = 19.8270x + 893.9566$ superimposed on it.

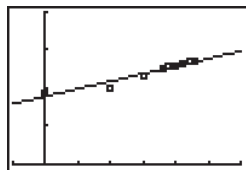

[-5, 30] by [0, 2000]

- (c) *Graphical solution:* Graph the two linear equations $y = 12.2614x + 979.5909$ and $y = 19.8270x + 893.9566$ on the same axis and find their point of intersection. The two curves intersect at $x \approx 11.3$.

The population of the two states will be the same sometime in the year 1991.

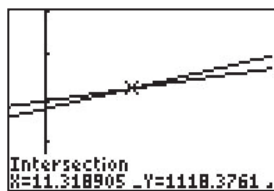

[-5, 30] by [0, 2000]

Another graphical solution would be to find where the graph of the difference of the two curves is equal to 0.

Algebraic solution:

Solve $12.2614x + 979.5909 = 19.8270x + 893.9566$ for x .

$$12.2614x + 979.5909 = 19.8270x + 893.9566$$

$$7.5656x = 85.6343$$

$$x = \frac{85.6343}{7.5656} \approx 11.3$$

The population of the two states will be the same sometime in the year 1991.

72. (a) According to data from the U. S. Census Bureau, there were 143.0 million males and 147.8 million females in 2003. The ratio of males to the total population is

$\frac{143}{290.8} \approx 0.4917$ and the ratio of females to the total population is $\frac{147.8}{290.8} \approx 0.5083$. If we define Matrix A

as the population matrix for the states of California, Florida, and Rhode Island, we have $A = \begin{matrix} \text{CA} \\ \text{FL} \\ \text{RI} \end{matrix} \begin{bmatrix} 35.5 \\ 17.0 \\ 1.1 \end{bmatrix}$.

If we define Matrix B as the ratio of males and females to the total population in 2003, we have

$$B = \begin{matrix} \text{M} & \text{F} \\ [0.4917 & 0.5083] \end{matrix}$$

The product AB gives the estimate of males and females in each of the three states in 2003.

$$C = \begin{matrix} & \text{M} & \text{F} \\ \begin{matrix} \text{CA} \\ \text{FL} \\ \text{RI} \end{matrix} & \begin{bmatrix} 35.5 \\ 17.0 \\ 1.1 \end{bmatrix} & \begin{bmatrix} 0.4917 & 0.5083 \end{bmatrix} = \begin{matrix} \text{CA} \\ \text{FL} \\ \text{RI} \end{matrix} \begin{bmatrix} 17.5 & 18.0 \\ 8.4 & 8.6 \\ 0.54 & 0.56 \end{bmatrix}$$

- (b) The matrix for the percentages of the populations of California, Florida, and Rhode Island under the age of 18 and age 65 or older is given as:

$$\begin{matrix} & <18 & \geq 65 \\ \begin{matrix} \text{CA} \\ \text{FL} \\ \text{RI} \end{matrix} & \begin{bmatrix} 26.5 & 10.6 \\ 23.1 & 17.0 \\ 22.8 & 14.0 \end{bmatrix} \end{matrix}$$

- (c) To change the matrix in (b) from percentages to decimals, multiply by the scalar 0.01 as follows:

$$0.01 \times \begin{matrix} & <18 & \geq 65 \\ \begin{matrix} \text{CA} \\ \text{FL} \\ \text{RI} \end{matrix} & \begin{bmatrix} 26.5 & 10.6 \\ 23.1 & 17.0 \\ 22.8 & 14.0 \end{bmatrix} = \begin{matrix} \text{CA} \\ \text{FL} \\ \text{RI} \end{matrix} \begin{bmatrix} 0.265 & 0.106 \\ 0.231 & 0.170 \\ 0.228 & 0.140 \end{bmatrix}$$

- (d) The transpose of the matrix in (c) is

$$\begin{bmatrix} 0.265 & 0.231 & 0.228 \\ 0.106 & 0.170 & 0.140 \end{bmatrix}$$

Multiplying the transpose of the matrix in (c) by the matrix in (a) gives the total number of males and females who are under the age of 18 or are 65 or older in all three states.

$$\begin{bmatrix} 0.265 & 0.231 & 0.228 \\ 0.106 & 0.170 & 0.140 \end{bmatrix} \begin{bmatrix} 17.5 & 18.0 \\ 8.4 & 8.6 \\ 0.54 & 0.56 \end{bmatrix} =$$

$$\begin{matrix} \text{M} & \text{F} \\ <18 & \begin{bmatrix} 6.7 & 6.9 \end{bmatrix} \\ \geq 65 & \begin{bmatrix} 3.4 & 3.4 \end{bmatrix} \end{matrix}$$

- (e) In 2003, there were about 6.7 million males under age 18 and about 3.4 million females 65 or older living in the three states.

73. (a) $N = [200 \quad 400 \quad 600 \quad 250]$

(b) $P = [\$80 \quad \$120 \quad \$200 \quad \$300]$

(c) $NP^T = [200 \quad 400 \quad 600 \quad 250] \begin{bmatrix} \$80 \\ \$120 \\ \$200 \\ \$300 \end{bmatrix} = \$259,000$

74. $(x, y) = (380, 72)$, where x is the number of students and y is the number of nonstudents.

$$x + y = 452$$

$$0.75x + 2.00y = 429$$

One method to solve the system is to solve by elimination as follows:

$$\begin{array}{r} 2x + 2y = 904 \\ 0.75x + 2y = 429 \\ \hline 1.25x = 475 \\ x = 380 \end{array}$$

Substitute $x = 380$ into $x + y = 452$ to solve for y .

75. Let x be the number of vans, $8x + 15y + 22 \geq 115$
 y be the number of small trucks, and z be the number of large trucks needed. The requirements of the problem are summarized above (along with the requirements that each of x , y , and z must be a non-negative integer). The methods of this chapter do not allow complete solution of this problem. Solving this system of *inequalities* as if it were a system of *equations* gives $(x, y, z) = (1.77, 3.30, 2.34)$, which suggests the answer $(x, y, z) = (2, 4, 3)$; one can easily check that $(x, y, z) = (2, 4, 2)$ actually works, as does $(1, 3, 3)$. The first of these solutions requires 8 vehicles, while the second requires only 7. There are a number of other seven-vehicle answers (these can be found by trial and error): Use no vans, anywhere from 0 to 5 small trucks, and the rest should be large trucks — that is, (x, y, z) should be one of $(0, 0, 7)$, $(0, 1, 6)$, $(0, 2, 5)$, $(0, 3, 4)$, $(0, 4, 3)$, or $(0, 5, 2)$.

76. $(x, y) = (21,333.33, 16,666.67)$, where x is the amount invested at 7.5% and y is the amount invested at 6%.

$$x + y = 38,000$$

$$0.075x + 0.06y = 2,600$$

One method to solve the system is to solve by substitution as follows:

$$\begin{array}{r} x + y = 38,000 \Rightarrow x = 38,000 - y \\ 0.075(38,000 - y) + 0.06y = 2600 \\ 2850 - 0.075y + 0.06y = 2600 \\ -0.015y = -250 \\ y = 16,666.67 \end{array}$$

Substitute $y = 16,666.67$ into $x + y = 38,000$ to solve for x .

77. $(x, y, z) = (160000, 170000, 320000)$, where x is the amount borrowed at 4%, y is the amount borrowed at 6.5%, and z is the amount borrowed at 9%. Solve the system below.

$$\begin{array}{r} x + y + z = 650,000 \\ 0.04x + 0.065y + 0.09z = 46,250 \\ 2x - z = 0 \end{array}$$

One method to solve the system is to solve using Gaussian elimination:

Multiply equation 1 by -0.065 and add the result to equation 2, replacing equation 2:

$$\begin{array}{r} x + y + z = 650,000 \\ -0.025x + 0.025z = 4000 \\ 2x - z = 0 \end{array}$$

Divide equation 2 by 0.025 to simplify:

$$\begin{array}{r} x + y + z = 650,000 \\ -x + z = 160,000 \\ 2x - z = 0 \end{array}$$

Now add equation 2 to equation 3, replacing equation 3:

$$\begin{array}{r} x + y + z = 650,000 \\ -x + z = 160,000 \\ x = 160,000 \end{array}$$

Substitute $x = 160,000$ into equation 2 to solve for z : $z = 320,000$. Substitute these values into equation 1 to solve for y : $y = 170,000$.

78. Sue: 9.3 hours (9 hours and 20 minutes), Esther: 12 hours, Murphy: 16.8 hours (16 hours 48 minutes). If x is the portion of the room Sue completes in one hour, y is the portion that Esther completes in one hour, and z is the portion that Murphy completes in one hour, then solving the system above gives $(x, y, z) = \left(\frac{3}{28}, \frac{1}{12}, \frac{5}{84}\right) = \left(\frac{1}{9.333}, \frac{1}{12}, \frac{1}{16.8}\right)$.

One method to solve the system is to find the row echelon form of the augmented matrix:

$$\begin{array}{c} \left[\begin{array}{cccc} 1 & 1 & 1 & 1/4 \\ 1 & 0 & 1 & 1/6 \\ 0 & 1 & 1 & 1/7 \end{array} \right] \xrightarrow{R_1 - R_2} \left[\begin{array}{cccc} 1 & 1 & 1 & 1/4 \\ 0 & 1 & 0 & 1/12 \\ 0 & 1 & 1 & 1/7 \end{array} \right] \\ \xrightarrow{R_1 - R_3} \left[\begin{array}{cccc} 1 & 0 & 0 & 3/28 \\ 0 & 1 & 0 & 1/12 \\ 0 & 1 & 1 & 1/7 \end{array} \right] \xrightarrow{R_3 - R_2} \\ \left[\begin{array}{cccc} 1 & 0 & 0 & 3/28 \\ 0 & 1 & 0 & 1/12 \\ 0 & 0 & 1 & 5/84 \end{array} \right] \end{array}$$

79. Pipe A: 15 hours. Pipe B: $\frac{60}{11} \approx 5.45$ hours (about

5 hours 27.3 minutes). Pipe C: 12 hours. If x is the portion of the pool that A can fill in one hour, y is the portion that B fills in one hour, and z is the portion that C fills in one hour, then solving the system above gives

$$(x, y, z) = \left(\frac{1}{15}, \frac{11}{60}, \frac{1}{12}\right)$$

One method to solve the system is to use elimination: Subtract equation 2 from equation 1:

$$\begin{array}{r} x + y + z = 1/3 \\ z = 1/12 \\ y + z = 4/15 \quad (\text{convert } 1/3.75 \text{ to simpler form}) \end{array}$$

Subtract equation 2 from equation 3:

$$\begin{array}{r} x + y + z = 1/3 \\ z = 1/12 \\ y = 11/60 \end{array}$$

Substitute the values for y and z into equation 1 to solve for x : $x = 1/15$.

- 80. B must be an $n \times n$ matrix. (There are n rows in B because AB is defined, and n columns in B since BA is defined.)
- 81. $n = p$ — the number of columns in A is the same as the number of rows in B .

Chapter 7 Project

- 1. The graphs are representative of the male and female population in the United States from 1990 to 2004, where x is the number of years after 1990.

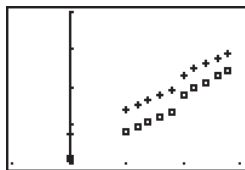

$[-5, 15]$ by $[120, 160]$

The linear regression equation for the male population is $y \approx 1.7585x + 119.5765$.

The linear regression equation for the female population is $y \approx 1.6173x + 126.4138$.

- 2. The slope is the rate of change of people (in millions) per year. The y -intercept is the number of people (either males or females) in 1990.
- 3. Yes, the male population is predicted to eventually surpass the female population, because the males' regression line

has a greater slope. But since 2000, the female population has always been greater. Since a span of only 15 years is represented, the data are most likely not enough to create a model for 100 or more years.

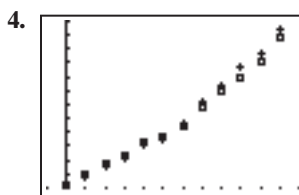

$[-10, 120]$ by $[30, 150]$

- 5. Males: $y \approx \frac{412.574}{1 + 10.956e^{(-0.01539x)}}$
 Females: $y \approx \frac{315.829}{1 + 9.031e^{(-0.01831x)}}$

The curves intersect at approximately $(45, 64)$; this represents the time when the female population became greater than the male population.

The curves intersect at approximately $(159, 212)$; this represents the time when the male population will again become greater the female population.

- 7. Approximately $\frac{138.1}{281.5} \approx 0.491 = 49.1\%$ male and 50.9% female